

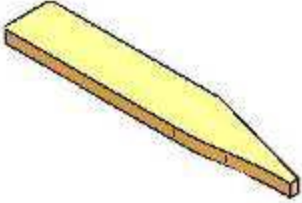

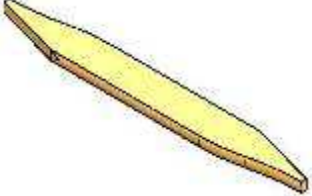

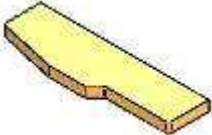

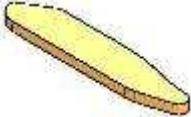

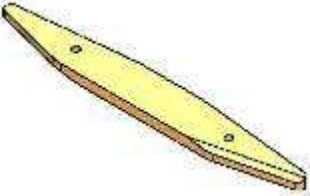

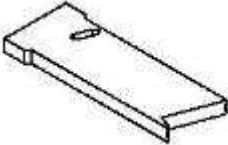
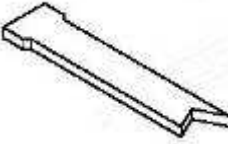

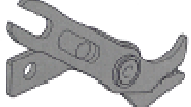

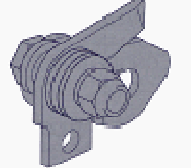
DORNIER RESELLERS PRICE LIST:







CODE	DESCRIPTION	
 338123	LH gripper opener plate for thin yarns 170x23x6mm	
 338416	LH gripper opener plate for thin yarns 170x23x6mm	
 338126D	Plate 170x23x6mm.	
 339033	Reference plate for thin yarn and fast machines 150x24x6	
 338128	RH gripper opener plate 85x24x6mm	
 APRD01	Double LH gripper opener plate 170x23x6	
 APRD02	Double LH gripper opener plate 195x23x6	









<p>338120D</p>	<p>Gripper opener 170mm (min. 50pcs)</p>	
 <p>345723</p>	<p>Gripper opener 140mm</p>	
 <p>APRD03</p>	<p>Double gripper opener plate 195x23mm</p>	
 <p>861100</p>	<p>RH retess. Gripper opener plate 100x25x6mm</p>	
 <p>736086</p>	<p>Gripper opener</p>	
 <p>APRD04</p>	<p>Gripper opener</p>	
<p>338127</p>	<p>Gripper opener (min. 50pcs)</p>	
<p>342836</p>	<p>Gripper opener (min. 100pcs)</p>	
<p>APRD05</p>	<p>Special gripper opener (min.50 pcs)</p>	
<p>345697</p>	<p>Gripper opener (min.100pz)</p>	
<p>349284</p>	<p>Gripper opener (min. 100pcs)</p>	
<p>344057</p>	<p>Gripper opener (fibra standard) (min.100pcs)</p>	
<p>348903</p>	<p>Gripper opener with holes</p>	
<p>348697</p>	<p>Gripper opener with holes</p>	
 <p>327286</p>	<p>Original small beam</p>	

 <p>TRCDRN</p>	Tawing device for waste selvage	
 <p>ANGDRN</p>	Tawing device for waste selvage (min.10pcs)	
 <p>335778</p>	Teflon lubricant pencil 60x14	
 <p>341205</p>	Teflon lubricant 70x26x5	
 <p>341206</p>	Teflon lubricant 64x18x4	
 <p>341207</p>	Teflon lubricant 74x16x4	
 <p>TEFLOD05</p>	23x46x19 Spessore 4mm (347268)	
 <p>337013</p>	Guide piece (ex.332856)	
<p>70614E</p>	Complete cutter	
<p>71129U</p>	Complete cutter	
<p>70897E</p>	LH cutter for motorized control 7 Degrees smooth	

 <p>343496</p>	Blade 2 for cutter 70897E	
<p>343497</p>	Blade 1 for cutter 70897E	
 <p>70898T</p>	RH cutter for motorized control 7 Degrees smooth (70898T)	
<p>343499</p>	Blade 2 for cutter 70989T	
<p>343498</p>	Blade 1 for cutter 70989T	
<p>71085N</p>	LH cutter for motorized control 20 Degrees micro serrated	
 <p>71085K</p>	Blade 2 for cutter 71085N	
<p>71085H</p>	Blade 1 for cutter 71085N	
<p>71085P</p>	RH cutter for motorized control 20 Degrees micro serrated	
<p>71085M</p>	Blade 2 for cutter 71085P	
<p>71085L</p>	Blade 1 for cutter 71085P	
 <p>763434</p>	Complete weft cutter, Smooth, 7 Degrees (72137U)	
<p>712525</p>	Complete weft cutter, Smooth, 20 Degrees	
<p>718570</p>	Complete weft cutter, Serrated, 20 Degrees	
 <p>472054</p>	Scissor, Part I, Smooth, 7 Degrees	
<p>764822</p>	Scissor, Part I, Smooth, 20 Degrees	
<p>764575</p>	Scissor, Part I, Serrated, 20 Degrees	
 <p>471105</p>	Scissors, Part II, Smooth, 7 Degrees	
<p>764821</p>	Scissors, Part II, Smooth, 20 Degrees	
<p>764574</p>	Scissors, Part II, Serrated, 20 Degrees	









 705804	Complete weft cutter LH, Smooth, 7 Degrees	
712544	Complete weft cutter LH, Smooth, 20 Degrees	
718576	Complete weft cutter LH, Serrated, 20 Degrees	
 471188	Scissor, Part I, Smooth, 7 Degrees for LH cutter	
764814	Scissor, Part I, Smooth, 20 Degrees for LH cutter	
764577	Scissor, Part I, Serrated, 20 Degrees for LH cutter	
 322552	Scissors, Part II, Smooth, 7 Degrees for LH cutter	
764819	Scissors, Part II, Smooth, 20 Degrees for LH cutter	
764576	Scissors, Part II, Serrated, 20 Degrees for LH cutter	
 705805	Complete weft cutter RH, Smooth, 7 Degrees	
712546	Complete weft cutter RH, Smooth, 20 Degrees	
718577	Complete weft cutter RH, Serrated, 20 Degrees	
 471198	Scissor, Part I, Smooth, 7 Degrees for RH cutter	
764820	Scissor, Part I, Smooth, 20 Degrees for RH cutter	
764587	Scissor, Part I, Serrated, 20 Degrees for RH cutter	
 322553	Scissors, Part II, Smooth, 7 Degrees for RH cutter	
764818	Scissors, Part II, Smooth, 20 Degrees for RH cutter	
764586	Scissors, Part II, Serrated, 20 Degrees for RH cutter	
767385	Complete weft cutter LH, Smooth, 7 Degrees – micro serrated	
767386	Complete weft cutter RH, Smooth, 7 Degrees – micro serrated	
718580	Complete cutter	
724329	Complete cutter 20°, serrated	
764588	Blade for cutter	
764576	Blade for cutter, 20°, serrated	







712534	Complete RHS tuck-in cutter 20°	
712530	Complete LHS tuck-in cutter 20°	
701060	Complete RHS tuck-in cutter 7°	
701059	Complete LHS tuck-in cutter 7°	
764589	Blade 20 degrees	
764590	Blade 20 degrees	
337393	Elastic ring for weft cutter	
 337394	Support pin for weft cutter	
 472001	Tungsten widia Carbide Sleeve	
 300925 – LD5038	Countersunk screw	
 736452 – LD5034	Cup spring (347268)	
465222	Small scissor (38x8x0,10 mm, Carbon)	
 712800	Weft insertion gear (from 22 to 99 teeth)	
345046	Small piston for electro valve	
533068	Round section belt 7,0 x 843	
331318	Toothed belt HTD 1080 – 8M – 20	
DBLT001	Toothbelt for dobby 540 H200	
DBLT002	Toothbelt for dobby 1630 55 AT-10	
DBLT003	Toothbelt for HTV-S 1610 HTD-14M-A X 50	
DBLT004	Toothbelt for 1610 HTD 14 MGT 55 polychain	
DBLT005	Toothbelt for dobby 1360 8M 20	
342706	Toothed belt for electronic colour selector	
 352783	Original Cartridge oil filter (ex.337420)	
345960	Original ball bearing (with special oil)	



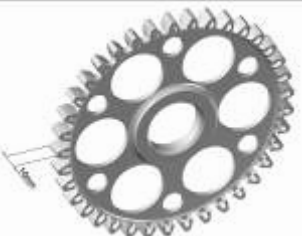



 <p>532915</p>	<p>Guide Roller Harex 19x43x14,5</p>	
 <p>533201</p>	<p>Guide Roller Harex 19x43x16</p>	
 <p>874398 – LD5003</p>	<p>Guide Roller Steel 43x20</p>	
 <p>874397 – LD5004</p>	<p>Guide Roller Steel 43x14</p>	
 <p>765706 – LD5005</p>	<p>Guide Roller Steel 38x20</p>	
 <p>764486 – LD5006</p>	<p>Guide Roller Steel 38x14</p>	
 <p>LD5007</p>	<p>Guide Roller Steel 36,7x20</p>	
 <p>70160H – LD5008</p>	<p>Guide Roller Steel 7x22x7</p>	
 <p>71032E - LD5009</p>	<p>Guide Roller Steel 8x22x10</p>	



 <p>383236</p>	<p>Rotor for double clutch ID. 338023</p>	
 <p>397977</p>	<p>Anchored wheel for double clutch ID.338023 (ex.383237)</p>	
 <p>394141</p>	<p>Clutch rotor</p>	
 <p>394142</p>	<p>Anchored wheel</p>	
 <p>347061</p>	<p>Anchored wheel (ex. 382606 – 381794)</p>	
 <p>347062</p>	<p>Brake rotor (ex. 382604)</p>	

 347063	Cluth rotor (ex. 382600)	
 373452	Anchored wheel (ex.394372)	
 383001	Anchored wheel (ex. 383000 – 382874 – 382958)	
 382873	Cluth rotor	
 394263	Anchored wheel (ex. 394387)	
 382870	Cluth rotor (ex. 382871)	

 <p>384062</p>	<p>Anchored wheel (ex. 382866 – 382867)</p>	
 <p>373432</p>	<p>Anchored wheel (ex. 394144)</p>	
 <p>394143</p>	<p>Cluth rotor</p>	
 <p>862078</p>	<p>Teethed disk (Dornier € 21,00 circa)</p>	
 <p>389520</p>	<p>Memory card 256K (ex.389518)</p>	
 <p>348821</p>	<p>Original NBE rubber cylinder covering 2,7mm</p>	
 <p>348895</p>	<p>Original RG rubber cylinder covering 2,5mm</p>	
 <p>430478</p>	<p>Green cloth 22 x 2,7mm auto adhesive</p>	

 <p>792941 – LD5062</p>	<p>Driving wheel steel, 37 teeth, 10mm (795154 old)</p>	
 <p>788822 – LD5063</p>	<p>Driving wheel steel, 37 teeth, 8mm</p>	
 <p>728784 – LD5001/1</p>	<p>Release Lever, short (or 701986)</p>	
<p>LD5001/2</p>	<p>Release Lever thin , short</p>	
<p>LD5001/3</p>	<p>Release Lever, short, special angle</p>	
 <p>728783 – LD5002/1</p>	<p>Release Lever, long (or 701985)</p>	
<p>LD5002/2</p>	<p>Release lever thin, long</p>	
<p>LD5002/3</p>	<p>Release Lever long, special angle</p>	
 <p>339362 – LD5011</p>	<p>Separator needle (532915 - 881811)</p>	
 <p>348440 – LD5012</p>	<p>Separator needle (881811 - 346058)</p>	
 <p>LD5016</p>	<p>RH Tuck-in Needle (339128)</p>	

 <p>LD5017</p>	<p>LH Tuck-in Needle (339129)</p>	
 <p>861026 – LD5014</p>	<p>RH Needle holder</p>	
 <p>861024 – LD5015</p>	<p>LH Needle holder</p>	
	<p>Original weft sensors (let us know code)</p>	
 <p>728861 – LD5054</p>	<p>Thread rod CPL. 160mm</p>	
 <p>70344U – LD5055</p>	<p>Thread rod CPL. 188mm</p>	
<p>70344Ucr – LD5060</p>	<p>Thread rod CPL. 188mm – chrome plated</p>	
 <p>70391L - LD5056</p>	<p>Thread rod CPL. 167mm</p>	

<p>LD5061</p>	<p>Thread rod CPL. 167mm – chrome plated</p>	
 <p>70391P - LD5057</p>	<p>Thread rod CPL. 165,5mm for big yarns (70391P, 70391L, 70791C)</p>	
 <p>337047 – LD5058</p>	<p>Ceramic bush</p>	
 <p>450153 – LD5059</p>	<p>Ceramic bush for big yarns</p>	

TEMPLES



57723/D
57723/S

LH and RH temples for heavyweight fabrics nr.24 rings



57721/D
57721/S

LH and RH temples with progress inclination rings.
For medium synthetic fabrics nr.25 rings



57044E/D
57044E/S

LH and RH temples for delicate fabrics



57733/D
57733/S

LH and RH temples for delicate fabrics



57678/D
57678/D

LH and RH temples for medium-weight shirting.



57714/D
57714/S

LH and RH temples for delicate fabrics

S1, LHS, E

1

853190 / 853314

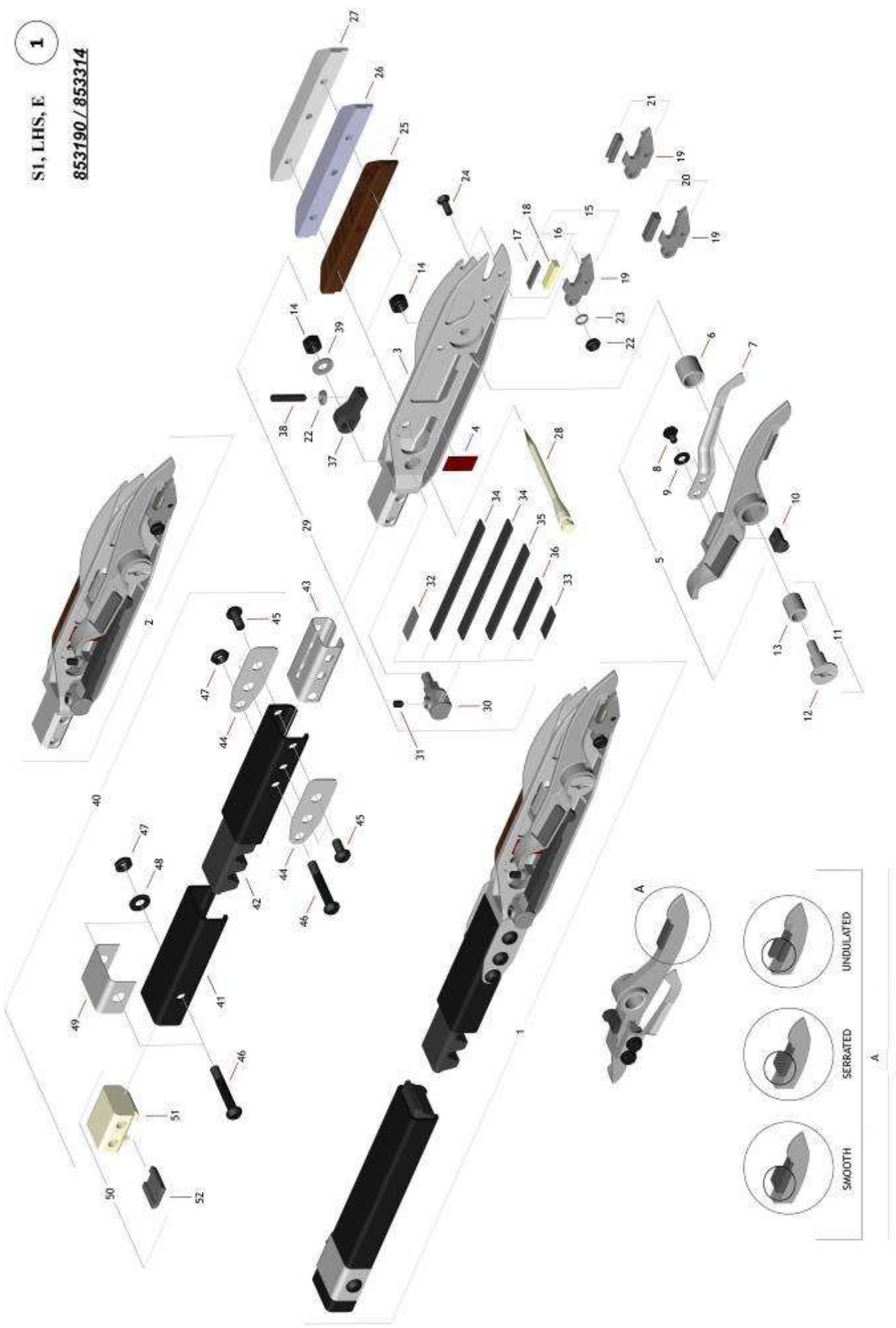

1	ORIGINAL – R.T.S CODES	DESCRIPTION	
1-A	853300 - LD2001/1	Rapier CPL., LHS, with vulkollan, smooth surface	
1-B	853298 - LD2001/2	Rapier CPL., LHS, with vulkollan, serrated surface	
1-C	702632 - LD2001/3	Rapier CPL., LHS, massive smooth surface	
1-D	707449 - LD2001/4	Rapier CPL., LHS, massive serrated surface	
1-E	LD2001/5	Rapier CPL., LHS, massive undulated surface	
2-A	853190 - LD2002/1	Rapier head CPL., LHS, with vulkollan, smooth surface	
2-B	853218 - LD2002/2	Rapier head CPL., LHS, with vulkollan, serrated surface	
2-C	853205 - LD2002/3	Rapier head CPL., LHS massive smooth surface	
2-D	853246 - LD2002/4	Rapier head CPL., LHS massive serrated surface	
2-E	LD2002/5	Rapier head CPL., LHS massive undulated surface	
3	853314 – LD2003	Rapier head body, LHS (<i>with item 4</i>)	
4	328090 - LD2004	Guide plate	
5-A	853356 – LD2005/1	Clamp lever CPL., LHS, smooth surface	
5-B	853358 – LD2005/2	Clamp lever CPL., LHS, serrated surface	
5-C	730236 - LD2005/3	Clamp lever CPL., LHS, undulated surface	
6	471117 - LD2006	Bush, Ø=10mm – L=9mm	
7	711906 – LD2007	Line feed lever	
8	311179 - LD2008	Hexhagon screw (M3x4)	
9	301701 - LD2009	Washer	
10	533023 - LD2010	Plastic plug	
11	LD2011	Bearing stud with bush	
12	711900 - LD2012	Bearing stud without bush	
13	471118 - LD2013	Bush, Ø=8mm – L=9,2mm	
14	311208 - LD2014	Nut, M4	
15-A	712311 – LD2015/1	Rapier jaw CPL., LHS, with vulkollan, smooth surface	
15-B	712312 – LD2015/2	Rapier jaw CPL., LHS, with vulkollan, serrated surface	
16-A	708854 - LD2016/1	Tungs. Carb. Ins., LHS, CPL, with vulkollan, smooth surface	
16-B	708856 - LD2016/2	Tungs. Carb. Ins., LHS, CPL, with vulkollan, serrated surface	
17-A	471160 - LD2017/1	Tungs. Carb. Ins., LHS, smooth surface	
17-B	471196 - LD2017/2	Tungs. Carb. Ins., LHS, serrated surface	
17-C	471410 – LD6025	Tungs. Carb. Ins., LHS, fine serrated surface	
18	533003 - LD2018	Vulkollan, LHS, 5mm (2,5 x 4 x 12,5mm)	
19	LD2019	Rapier jaw body, LHS	
20-A	853178 - LD2020/1	Rapier jaw CPL., LHS, massive smooth surface	
20-B	853244 - LD2020/2	Rapier jaw CPL., LHS, massive serrated surface	
21	LD2021	Rapier jaw CPL., LHS, massive undulated surface	

22	311206 - LD2022	Nut, M3	
23	341914 – LD2023	Washer	
24	337910 - LD2024	Countersunk screw (M3 x 6)	
25	334069 - LD2025	Guide piece, LHS, harex	
26	334068 - LD2026	Guide piece, LHS, grey	
27	334067 - LD2027	Guide piece, LHS, white	
28	328321 – LD2028	Locking element	
29	711895 – LD2029	Clamping spring CPL., LHS	
30	707873 - LD2030	Clamping stud, LHS	
31	309758 - LD2031	Setscrew (M3x4)	
32	711576 - LD2032	Upper guide plate (0,5 x 6 x 14mm)	
33	410826 - LD2033	Lower guide plate (0,1 x 6 x 14mm)	
34	322842 - LD2034	Spring (1,1 x 6 x 64mm)	
35	322843 - LD2035	Spring (1,1 x 6 x 50mm)	
36	322844 - LD2036	Spring (1,1 x 6 x 30mm)	
37	769850 – LD2037	Stop piece, LHS	
38	309757 - LD2038	Setscrew (M3x16)	
39	301702 – LD2039	Washer	
43	853316 - LD2043	Adaptor	
44	490150 - LD2044	Protecting sheet, 10mm	
45	322532 - LD2045	Oval head screw (M4x8)	
46	322502 - LD2046	Oval head screw (M4x25)	
47	322001 - LD2047	Nut, M4	
48	410301 - LD2048	Spring washer	
49	853329 - LD2049	Protecting sheet (<i>for 10mm</i>)	
50	700155 - LD2050	Sliding piece CPL.	
51	533287 - LD2051	Sliding piece	
52	471398 – LD2052	Tungsten carbide piece	

S1, RHS, E

2

853191 / 853315

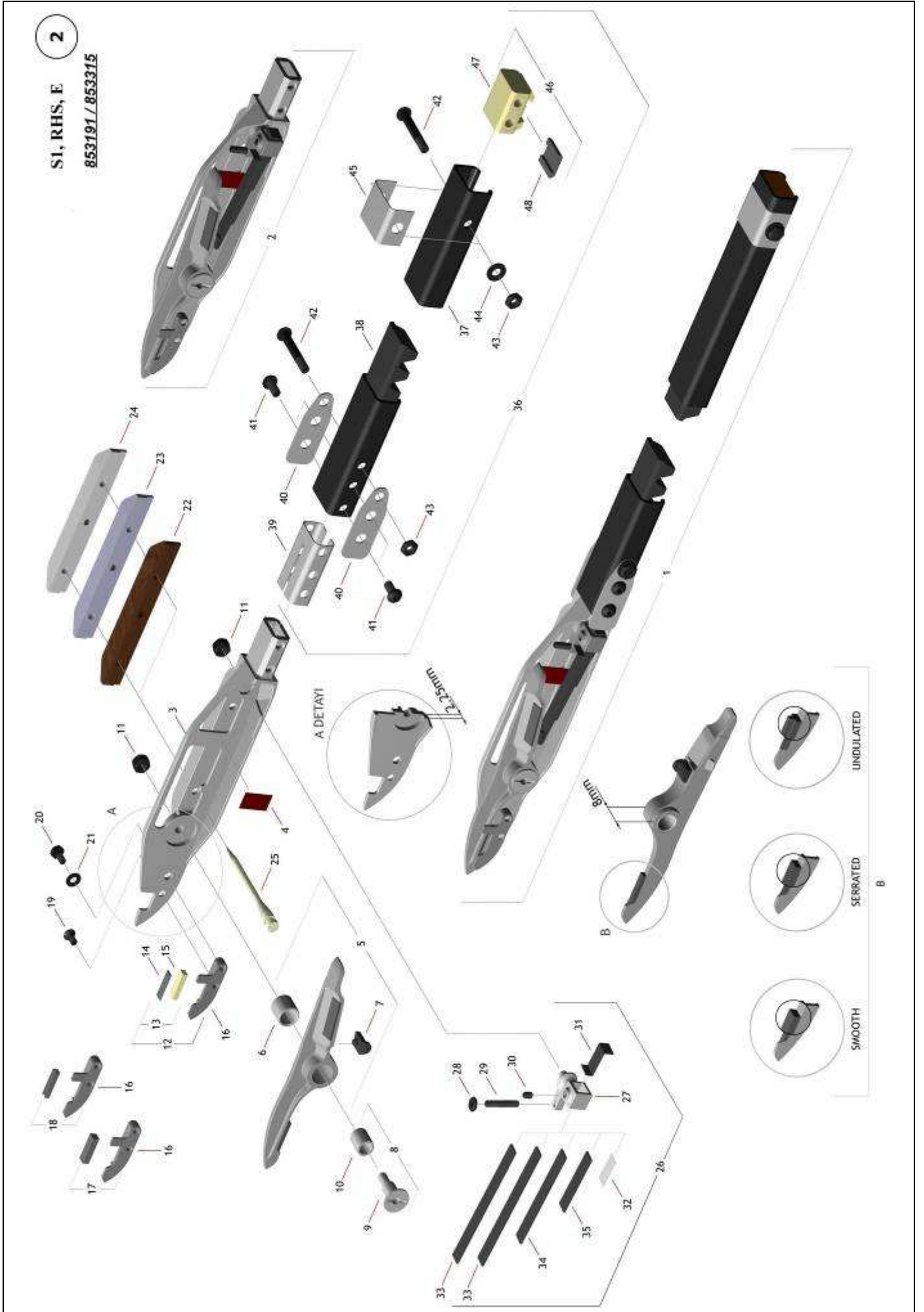

2	ORIGINAL – R.T.S CODES	DESCRIPTION	
1-A	853301 - LD2053/1	Rapier CPL., RHS, with vulkollan, smooth surface	
1-B	853299 - LD2053/2	Rapier CPL., RHS, with vulkollan, serrated surface	
1-C	702633 - LD2053/3	Rapier CPL., RHS, massive smooth surface	
1-D	707457 - LD2053/4	Rapier CPL., RHS, massive serrated surface	
1-E	LD2053/5	Rapier CPL., RHS, massive undulated surface	
2-A	853191 - LD2054/1	Rapier head CPL., RHS, with vulkollan, smooth surface	
2-B	853219 - LD2054/2	Rapier head CPL., RHS, with vulkollan, serrated surface	
2-C	853206 - LD2054/3	Rapier head CPL., RHS massive smooth surface	
2-D	853247 - LD2054/4	Rapier head CPL., RHS massive serrated surface	
2-E	LD2054/5	Rapier head CPL., RHS massive undulated surface	
3	853315 - LD2055	Rapier head body, RHS (<i>with item 4</i>)	
4	328090 - LD2004	Guide plate	
5-A	853194 - LD2056/1	Clamp lever CPL., RHS, smooth surface	
5-B	853215 - LD2056/2	Clamp lever CPL., RHS, serrated surface	
5-C	LD2056/3	Clamp lever CPL., RHS, undulated surface	
6	471117 - LD2006	Bush, Ø=10mm – L=9mm	
7	533023 - LD2010	Plastic plug	
8	LD2011	Bearing stud with bush	
9	711900 - LD2012	Bearing stud without bush	
10	471118 - LD2013	Bush, Ø=8mm – L=9,2mm	
11	311208 - LD2014	Nut, M4	
12-A	853177 - LD2057/1	Rapier jaw CPL., RHS, with vulkollan, smooth surface	
12-B	853217 - LD2057/2	Rapier jaw CPL., RHS, with vulkollan, serrated surface	
13-A	708855 - LD2058/1	Tungs. Carb. Ins., RHS, CPL, with vulkollan, smooth surface	
13-B	708857 - LD2058/2	Tungs. Carb. Ins., RHS, CPL, with vulkollan, serrated surface	
14-A	471159 - LD2059/1	Tungs. Carb. Ins., RHS, smooth surface	
14-B	471191 - LD2059/2	Tungs. Carb. Ins., RHS, serrated surface	
15	533004 - LD2060	Vulkollan, RHS, 5mm (2,5 x 2,8 x 12,5mm)	
16	LD2061	Rapier jaw body, RHS	
17-A	853179 - LD2062/1	Rapier jaw CPL., RHS, massive smooth surface	
17-B	853245 - LD2062/2	Rapier jaw CPL., RHS, massive serrated surface	
18	LD2063	Rapier jaw CPL., RHS, massive undulated surface	
19	312048 - LD2064	Countersunk screw (M3 x 4)	
20	310943 - LD2065	Hexagon (M3 x 6)	
21	341914 – LD2023	Washer	
22	334069 - LD2025	Guide piece, LHS, harex	

23	334068 - LD2026	Guide piece, LHS, grey	
24	334037 - LD2027	Guide piece, LHS, white	
25	328321 - LD2028	Locking element	
26	711896 - LD2069	Clamping spring CPL., RHS (731082-731082)	
27	707861 - LD2070	Clamping stud, RHS	
28	311206 - LD2022	Nut, M3	
29	309757 - LD2038	Setscrew (M3x16)	
30	309767 - LD2071	Setscrew (M4x4)	
31	410948 - LD2072	Upper guide plate, "Z" form	
32	410826 - LD2033	Lower guide plate (0,1 x 6 x 14mm)	
33	322842 - LD2034	Spring (1,1 x 6 x 64mm)	
34	322843 - LD2035	Spring (1,1 x 6 x 50mm)	
35	322844 - LD2036	Spring (1,1 x 6 x 30mm)	
39	853316 - LD2043	Adaptor	
40	490150 - LD2044	Protecting sheet, 10mm	
41	322532 - LD2045	Oval head screw (M4x8)	
42	322502 - LD2046	Oval head screw (M4x25)	
43	322001 - LD2047	Nut, M4	
44	410301 - LD2048	Spring washer	
45	853329 - LD2049	Protecting sheet (for 10mm)	
46	700155 - LD2050	Sliding piece CPL.	
47	533287 - LD2051	Sliding piece	
48	471398 - LD2052	Tungsten carbide piece	

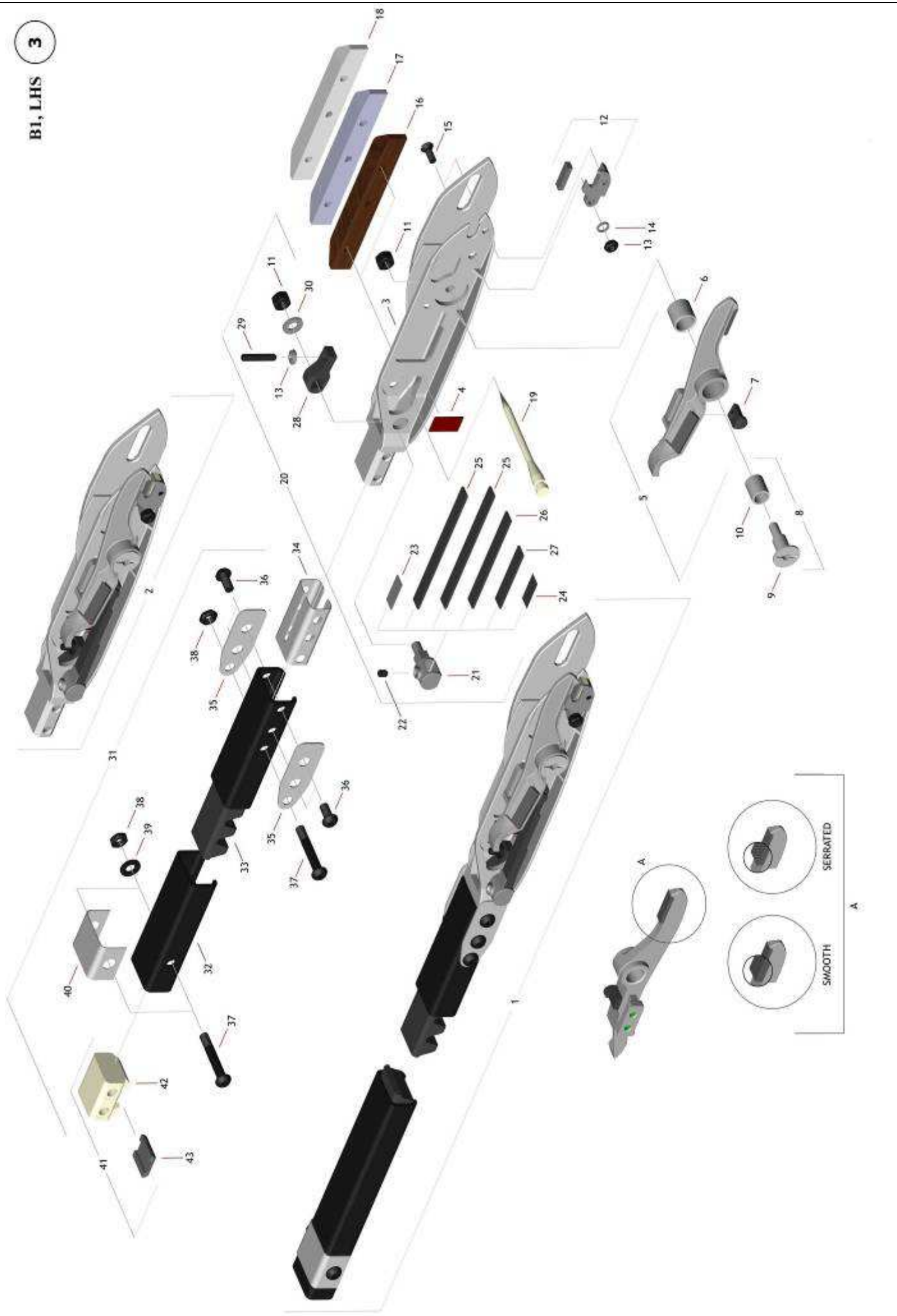

3	ORIGINAL – R.T.S CODES	DESCRIPTION	
1-A	LD2073/1	Rapier CPL., LHS, massive smooth surface	
1-B	707505 - LD2073/2	Rapier CPL., LHS, massive serrated surface	
2-A	LD2074/1	Rapier head CPL., LHS massive smooth surface	
2-B	853273 - LD2074/2	Rapier head CPL., LHS massive serrated surface	
3	702491 - LD2075	Rapier head body, LHS (<i>with item 4</i>)	
4	328090 - LD2004	Guide plate	
5-A	LD2076/1	Clamp lever CPL., LHS, smooth surface	
5-B	702969 - LD2076/2	Clamp lever CPL., LHS, serrated surface	
6	471117 - LD2006	Bush, Ø=10mm – L=9mm	
7	533023 - LD2010	Plastic plug	
8	LD2011	Bearing stud with bush	
9	711900 - LD2012	Bearing stud without bush	
10	471118 - LD2013	Bush, Ø=8mm – L=9,2mm	
11	311208 - LD2014	Nut, M4	
12-A	LD2077/1	Rapier jaw CPL., LHS, massive smooth surface	
12-B	853296 - LD2077/2	Rapier jaw CPL., LHS, massive serrated surface	
13	311206 - LD2022	Nut, M3	
14	341914 – LD2023	Washer	
15	337910 - LD2024	Countersunk screw (M3 x 6)	
16	334069 - LD2025	Guide piece, LHS, harex	
17	334068 - LD2026	Guide piece, LHS, grey	
18	334067 - LD2027	Guide piece, LHS, white	
19	328321 – LD2028	Locking element	
20	711895 – LD2029	Clamping spring CPL., LHS	
21	707873 - LD2030	Clamping stud, LHS	
22	309758 - LD2031	Setscrew (M3x4)	
23	711576 - LD2032	Upper guide plate (0,5 x 6 x 14mm)	
24	410826 - LD2033	Lower guide plate (0,1 x 6 x 14mm)	
25	322842 - LD2034	Spring (1,1 x 6 x 64mm)	
26	322843 - LD2035	Spring (1,1 x 6 x 50mm)	
27	322844 - LD2036	Spring (1,1 x 6 x 30mm)	
28	769850 – LD2037	Stop piece, LHS	
29	309757 - LD2038	Setscrew (M3x16)	
30	301702 – LD2039	Washer	
34	853316 - LD2043	Adaptor	
35	490150 - LD2044	Protecting sheet, 10mm	

36	322532 - LD2045	Oval head screw (M4x8)	
37	322502 - LD2046	Oval head screw (M4x25)	
38	322001 - LD2047	Nut, M4	
39	410301 - LD2048	Spring washer	
40	853329 - LD2049	Protecting sheet (<i>for 10mm</i>)	
41	700155 - LD2050	Sliding piece CPL.	
42	533287 - LD2051	Sliding piece	
43	471398 - LD2052	Tungsten carbide piece	

S2, LHS, E

4

764194 / 764555

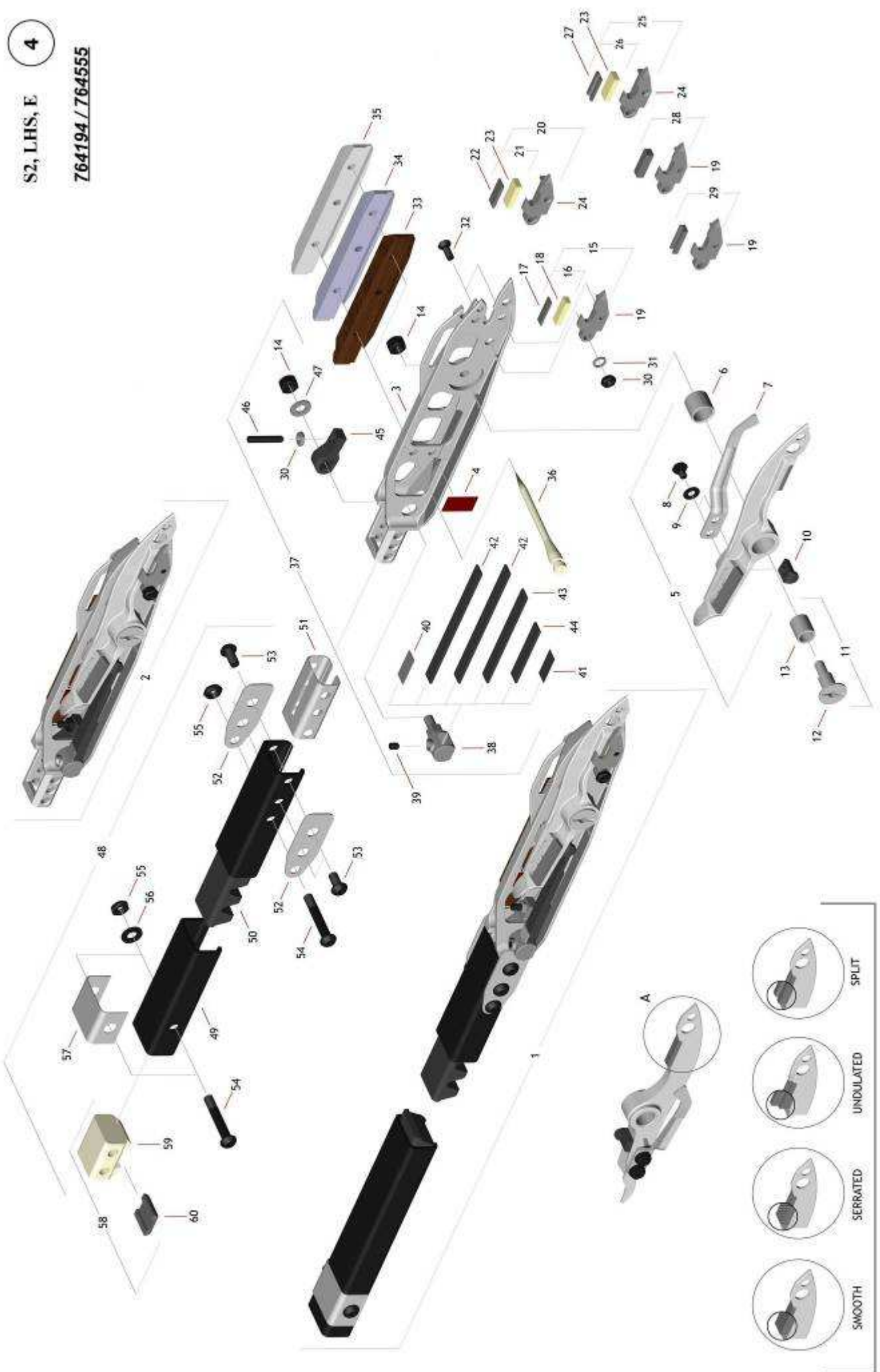

- SMOOTH
- SERRATED
- UNDCULATED
- SPLIT

A

4	ORIGINAL – R.T.S CODES	DESCRIPTION	
1-A	714887 - LD2079/1	Rapier CPL., LHS, with vulkollan, smooth surface	
1-B	714893 - LD2079/2	Rapier CPL., LHS, with vulkollan, serrated surface	
1-C	729047 - LD2079/3	Rapier CPL., LHS, with vulkollan, smooth surface, 5mm	
1-D	731729 - LD2079/4	Rapier CPL., LHS, with vulkollan, serrated surface, 5mm	
1-E	LD2079/5	Rapier CPL., LHS, with vulkollan, split, smooth surface, 5mm	
1-F	LD2079/6	Rapier CPL., LHS, with vulkollan, split, serrated surface, 5mm	
1-G	714890 - LD2079/7	Rapier CPL., LHS, massive smooth surface	
1-H	716042 - LD2079/8	Rapier CPL., LHS, massive serrated surface	
1-I	LD2079/9	Rapier CPL., LHS, massive undulated surface	
2-A	764194 - LD2080/1	Rapier head CPL., LHS, with vulkollan, smooth surface (714831)	
2-B	764441 - LD2080/2	Rapier head CPL., LHS, with vulkollan, serrated surface (714848)	
2-B	764443 – LD6071	Rapier head CPL., LHS, with vulkollan, fine serrated surface	
2-B	714859 – LD6071	Rapier head CPL., LHS, with vulkollan, fine serrated surface	
2-C	729000 – LD2080/3	Rapier head CPL., LHS, with vulkollan, smooth surface, 5mm	
2-D	731728 – LD2080/4	Rapier head CPL., LHS, with vulkollan, serrated surface, 5mm	
2-E	LD2080/5	Rapier head CPL., LHS, with vulkollan, split, smooth surface, 5mm	
2-F	LD2080/6	Rapier head CPL., LHS, with vulkollan, split, serrated surface, 5mm	
2-G	717842 – LD2080/7	Rapier head CPL., LHS massive smooth surface	
2-H	716037 – LD2080/8	Rapier head CPL., LHS massive serrated surface	
2-I	LD2080/9	Rapier head CPL., LHS massive undulated surface	
3	714555 – LD2081	Rapier head body, LHS (with item 4)	
4	328090 – LD2004	Guide plate	
5-A	730225 – LD2082/1	Clamp lever CPL., LHS, smooth surface	
5-B	730228 – LD2082/2	Clamp lever CPL., LHS, serrated surface	
5-C	730233 – LD6069	Clamp lever CPL., LHS, fine serrated surface	
5-C	728992 – LD2082/3	Clamp lever CPL., LHS, smooth surface, 5mm	
5-D	730231 – LD2082/4	Clamp lever CPL., LHS, serrated surface, 5mm	
5-E	LD2082/5	Clamp lever CPL., LHS, split, smooth surface, 5mm	
5-F	LD2082/6	Clamp lever CPL., LHS, split, serrated surface, 5mm	
5-G	LD2082/7	Clamp lever CPL., LHS, undulated surface	
6	471117 – LD2006	Bush, Ø=10mm – L=9mm	
7	711906 – LD2007	Line feed lever	
8	311701 – LD2008	Hexhagon screw (M3x4)	
9	301701 – LD2009	Washer	
10	533023 – LD2010	Plastic plug	
11	LD2011	Bearing stud with bush	

12	711900 – LD2012	Bearing stud without bush	
13	471118 – LD2013	Bush, Ø=8mm – L=9,2mm	
14	311208 – LD2014	Nut, M4	
15-A	712311 – LD2015/1	Rapier jaw CPL., LHS, with vulkollan, smooth surface (712308)	
15-B	712312 – LD2015/2	Rapier jaw CPL., LHS, with vulkollan, serrated surface	
15-B	712313 - LD6016	Rapier jaw CPL., LHS, with vulkollan, fine serrated surface	
16-A	708854 – LD2016/1	Tungs. Carb. Ins., LHS, CPL, with vulkollan, smooth surface	
16-B	708856 – LD2016/2	Tungs. Carb. Ins., LHS, CPL, with vulkollan, serrated surface	
17-A	471160 – LD2017/1	Tungs. Carb. Ins., LHS, smooth surface	
17-B	471196 – LD2017/2	Tungs. Carb. Ins., LHS, serrated surface	
18	533003 – LD2018	Vulkollan, LHS, 5mm (2,5 x 4 x 12,5mm)	
19	LD2019	Rapier jaw body, LHS	
20-A	724063 – LD2083/1	Rapier jaw CPL., LHS, with vulkollan, smooth surface, 5mm	
20-B	730572 – LD2083/2	Rapier jaw CPL., LHS, with vulkollan, serrated surface, 5mm	
21-A	724065 – LD2084/1	Tungs. Carb. Ins., LHS, CPL, with vulkollan, smooth surface, 5mm	
21-B	730573 – LD2084/2	Tungs. Carb. Ins., LHS, CPL, with vulkollan, serrated surface, 5mm	
22-A	327726 – LD2085/1	Tungs. Carb. Ins., LHS, smooth surface, 5mm	
22-B	329658 – LD2085/2	Tungs. Carb. Ins., LHS, serrated surface, 5mm	
23	327727 – LD2086	Vulkollan, LHS, 5mm (2,5 x 5 x 12,5mm)	
24	LD2087	Rapier Jaw body, LHS, 5mm	
25-A	LD2088/1	Rapier jaw CPL., LHS, with vulkollan, split smooth surface, 5mm	
25-B	LD2088/2	Rapier jaw CPL., LHS, with vulkollan, split serrated surface, 5mm	
26-A	LD2089/1	Tungs. Carb. Ins., LHS, CPL, with vulkollan, split smooth surface, 5mm	
26-B	LD2089/2	Tungs. Carb. Ins., LHS, CPL, with vulkollan, split serrated surface, 5mm	
27-A	LD2090/1	Tungs. Carb. Ins., LHS, split smooth surface, 5mm	
27-B	LD2090/2	Tungs. Carb. Ins., LHS, split serrated surface, 5mm	
28-A	764270 – LD2091/1	Rapier jaw CPL., LHS, massive smooth surface	
28-B	764439 – LD2091/2	Rapier jaw CPL., LHS, massive serrated surface	
29	LD2092	Rapier jaw CPL., LHS, massive undulated surface	
30	311206 – LD2022	Nut, M3	
31	341914 – LD2023	Washer	
32	337910 – LD2024	Countersunk screw (M3 x 6)	
33	335507 – LD2066	Guide piece, LHS, harex (333448)	
34	333449 – LD2067	Guide piece, LHS, grey	
35	343450 – LD2068	Guide piece, LHS, white	
36	328321 – LD2028	Locking element	
37	711895 – LD2029	Clamping spring CPL., LHS	

38	707873 – LD2030	Clamping stud, LHS	
39	309758 – LD2031	Setscrew (M3x4)	
40	711576 – LD2032	Upper guide plate (0,5 x 6 x 14mm)	
41	410826 – LD2033	Lower guide plate (0,1 x 6 x 14mm)	
42	322842 – LD2034	Spring (1,1 x 6 x 64mm)	
43	322843 – LD2035	Spring (1,1 x 6 x 50mm)	
44	322844 – LD2036	Spring (1,1 x 6 x 30mm)	
45	769850 – LD2037	Stop piece, LHS	
46	309757 – LD2038	Setscrew (M3x16)	
47	301702 – LD2039	Washer	
51	853316 – LD2043	Adaptor	
52	490150 – LD2044	Protecting sheet, 10mm (324444)	
53	322532 – LD2045	Oval head screw (M4x8)	
54	322502 – LD2046	Oval head screw (M4x25)	
55	322001 – LD2047	Nut, M4	
56	410301 – LD2048	Spring washer	
57	853329 – LD2049	Protecting sheet, 10mm	
58	700155 – LD2050	Sliding piece CPL.	
59	533287 – LD2051	Sliding piece	
60	471398 – LD2052	Tungsten carbide piece	

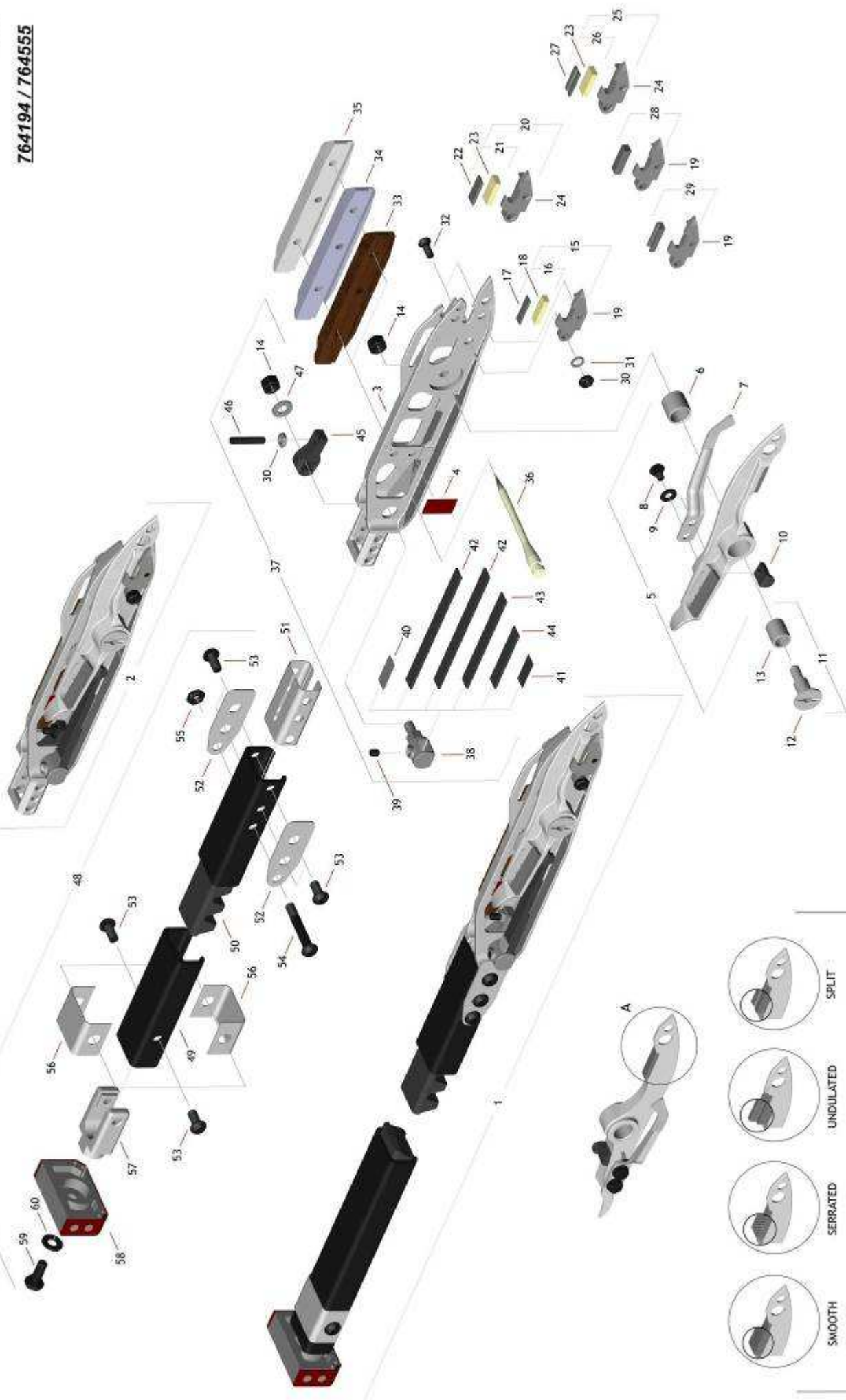

5	ORIGINAL – R.T.S CODES	DESCRIPTION	
1-A	714887 – LD2079/1	Rapier CPL., LHS, with vulkollan, smooth surface	
1-B	714893 – LD2079/2	Rapier CPL., LHS, with vulkollan, serrated surface	
1-C	729047 – LD2079/3	Rapier CPL., LHS, with vulkollan, smooth surface, 5mm	
1-D	731729 – LD2079/4	Rapier CPL., LHS, with vulkollan, serrated surface, 5mm	
1-E	LD2079/5	Rapier CPL., LHS, with vulkollan, split, smooth surface, 5mm	
1-F	LD2079/6	Rapier CPL., LHS, with vulkollan, split, serrated surface, 5mm	
1-G	714890 – LD2079/7	Rapier CPL., LHS, massive smooth surface	
1-H	716042 – LD2079/8	Rapier CPL., LHS, massive serrated surface	
1-I	LD2079/9	Rapier CPL., LHS, massive undulated surface	
2-A	764194 – LD2080/1	Rapier head CPL., LHS, with vulkollan, smooth surface	
2-B	764441 – LD2080/2	Rapier head CPL., LHS, with vulkollan, serrated surface	
2-B	764443	Rapier head CPL., LHS, with vulkollan, fine serrated surface	
2-C	729000 – LD2080/3	Rapier head CPL., LHS, with vulkollan, smooth surface, 5mm	
2-D	731728 – LD2080/4	Rapier head CPL., LHS, with vulkollan, serrated surface, 5mm	
2-E	LD2080/5	Rapier head CPL., LHS, with vulkollan, split, smooth surface, 5mm	
2-F	LD2080/6	Rapier head CPL., LHS, with vulkollan, split, serrated surface, 5mm	
2-G	714842 – LD2080/7	Rapier head CPL., LHS massive smooth surface	
2-H	716037 – LD2080/8	Rapier head CPL., LHS massive serrated surface	
2-I	LD2080/9	Rapier head CPL., LHS massive undulated surface	
	730233 - LD6069	Rapier head CPL., LHS fine serrated	
3	714555 – LD2081	Rapier head body, LHS (<i>with item 4</i>)	
4	328090 – LD2004	Guide plate	
5-A	730225 – LD2082/1	Clamp lever CPL., LHS, smooth surface	
5-B	730228 – LD2082/2	Clamp lever CPL., LHS, serrated surface	
5-C	728992 – LD2082/3	Clamp lever CPL., LHS, smooth surface, 5mm	
5-D	730231 – LD2082/4	Clamp lever CPL., LHS, serrated surface, 5mm	
5-E	LD2082/5	Clamp lever CPL., LHS, split, smooth surface, 5mm	
5-F	LD2082/6	Clamp lever CPL., LHS, split, serrated surface, 5mm	
5-G	LD2082/7	Clamp lever CPL., LHS, undulated surface	
6	471117 – LD2006	Bush, Ø=10mm – L=9mm	
7	711906 – LD2007	Line feed lever	
8	311179 – LD2008	Hexhagon screw (M3x4)	
9	301701 – LD2009	Washer	
10	533023 – LD2010	Plastic plug	
11	LD2011	Bearing stud with bush	
12	711900 – LD2012	Bearing stud without bush	

13	471118 – LD2013	Bush, Ø=8mm – L=9,2mm	
14	311208 – LD2014	Nut, M4	
15-A	712311 – LD2015/1	Rapier jaw CPL., LHS, with vulkollan, smooth surface	
15-B	712312 – LD2015/2	Rapier jaw CPL., LHS, with vulkollan, serrated surface	
15-B	712313	Rapier jaw CPL., LHS, with vulkollan, fine serrated surface	
16-A	708854 – LD2016/1	Tungs. Carb. Ins., LHS, CPL, with vulkollan, smooth surface	
16-B	708856 – LD2016/2	Tungs. Carb. Ins., LHS, CPL, with vulkollan, serrated surface	
16-B	708858 - LD6020	Tungs. Carb. Ins., LHS, CPL, with vulkollan, fine serrated surface	
17-A	471160 – LD2017/1	Tungs. Carb. Ins., LHS, smooth surface	
17-B	471196 – LD2017/2	Tungs. Carb. Ins., LHS, serrated surface	
18	533003 – LD2018	Vulkollan, LHS, 5mm (2,5 x 4 x 12,5mm)	
19	LD2019	Rapier jaw body, LHS	
20-A	724063 – LD2083/1	Rapier jaw CPL., LHS, with vulkollan, smooth surface, 5mm	
20-B	730572 – LD2083/2	Rapier jaw CPL., LHS, with vulkollan, serrated surface, 5mm	
21-A	724065 – LD2084/1	Tungs. Carb. Ins., LHS, CPL, with vulkollan, smooth surface, 5mm	
21-B	730573 – LD2084/2	Tungs. Carb. Ins., LHS, CPL, with vulkollan, serrated surface, 5mm	
22-A	327726 – LD2085/1	Tungs. Carb. Ins., LHS, smooth surface, 5mm	
22-B	329658 – LD2085/2	Tungs. Carb. Ins., LHS, serrated surface, 5mm	
23	327727 – LD2086	Vulkollan, LHS, 5mm (2,5 x 5 x 12,5mm)	
24	LD2087	Rapier Jaw body, LHS, 5mm	
25-A	LD2088/1	Rapier jaw CPL., LHS, with vulkollan, split smooth surface, 5mm	
25-B	LD2088/2	Rapier jaw CPL., LHS, with vulkollan, split serrated surface, 5mm	
26-A	LD2089/1	Tungs. Carb. Ins., LHS, CPL, with vulkollan, split smooth surface, 5mm	
26-B	LD2089/2	Tungs. Carb. Ins., LHS, CPL, with vulkollan, split serrated surface, 5mm	
27-A	LD2090/1	Tungs. Carb. Ins., LHS, split smooth surface, 5mm	
27-B	LD2090/2	Tungs. Carb. Ins., LHS, split serrated surface, 5mm	
28-A	764270 – LD2091/1	Rapier jaw CPL., LHS, massive smooth surface	
28-B	764439 – LD2091/2	Rapier jaw CPL., LHS, massive serrated surface	
29	LD2092	Rapier jaw CPL., LHS, massive undulated surface	
30	311206 – LD2022	Nut, M3	
31	341914 – LD2023	Washer	
32	337910 – LD2024	Countersunk screw (M3 x 6)	
33	335507 – LD2066	Guide piece, LHS, harex (333448)	
34	333449 – LD2067	Guide piece, LHS, grey	
35	343450 – LD2068	Guide piece, LHS, white	
36	328321 – LD2028	Locking element	
37	711895 – LD2029	Clamping spring CPL., LHS	

38	707873 – LD2030	Clamping stud, LHS	
39	309758 – LD2031	Setscrew (M3x4)	
40	711576 – LD2032	Upper guide plate (0,5 x 6 x 14mm)	
41	410826 – LD2033	Lower guide plate (0,1 x 6 x 14mm)	
42	322842 – LD2034	Spring (1,1 x 6 x 64mm)	
43	322843 – LD2035	Spring (1,1 x 6 x 50mm)	
44	322844 – LD2036	Spring (1,1 x 6 x 30mm)	
45	769850 – LD2037	Stop piece, LHS	
46	309757 – LD2038	Setscrew (M3x16)	
47	301702 – LD2039	Washer	
51	853316 – LD2043	Adaptor	
52	490150 – LD2044	Protecting sheet, 10mm	
53	322532 – LD2045	Oval head screw (M4x8)	
54	322502 – LD2046	Oval head screw (M4x25)	
55	322001 – LD2047	Nut, M4	
56	853329 – LD2049	Protecting sheet, 10mm	
57	334982 – LD2094	Stop piece, 10mm, "U" form	
58	339317 – LD2095	Guide piece, 10mm	
59	311066 – LD2096	Hexagon screw (M4x10)	
60	410301 – LD2048	Spring washer	

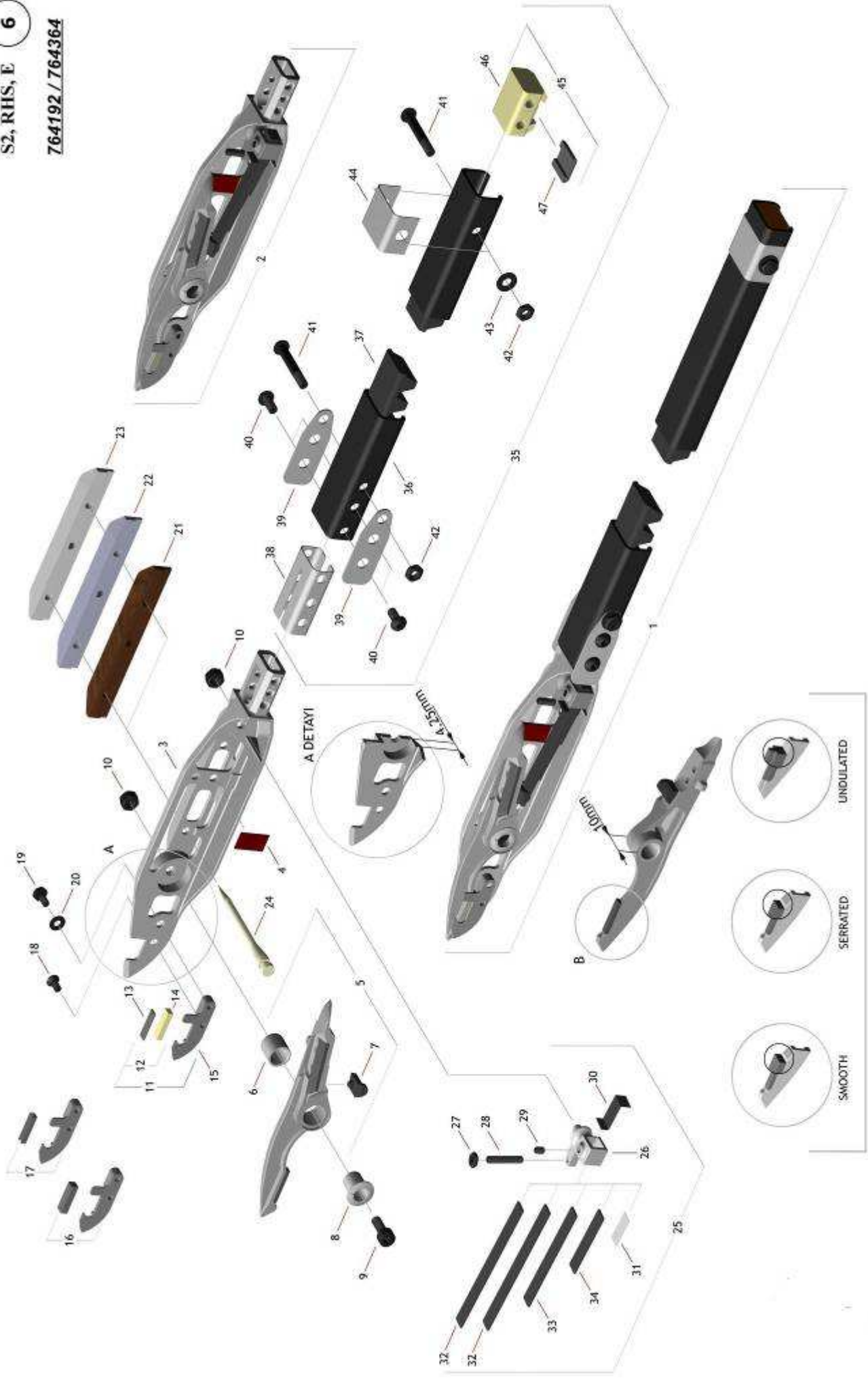

6	ORIGINAL – R.T.S CODES	DESCRIPTION	
1-A	LD2097/1	Rapier CPL., RHS, with vulkollan, smooth surface	
1-B	LD2097/2	Rapier CPL., RHS, with vulkollan, serrated surface	
1-C	LD2097/3	Rapier CPL., RHS, massive smooth surface	
1-D	LD2097/4	Rapier CPL., RHS, massive serrated surface	
1-E	LD2097/5	Rapier CPL., RHS, massive undulated surface	
2-A	764192 – LD2098/1	Rapier head CPL., RHS, with vulkollan, smooth surface	
2-B	764419 – LD2098/2	Rapier head CPL., RHS, with vulkollan, serrated surface	
2-B	764436	Rapier head CPL., RHS, with vulkollan, fine serrated surface	
2-C	LD2098/3	Rapier head CPL., RHS massive smooth surface	
2-D	LD2098/4	Rapier head CPL., RHS massive serrated surface	
2-E	LD2098/5	Rapier head CPL., RHS massive undulated surface	
3	767652 – LD2099	Rapier head body, RHS (<i>with item 4</i>) (764364)	
4	328090 – LD2004	Guide plate	
5-A	764293 – LD2100/1	Clamp lever CPL., RHS, smooth surface (790730)	
5-B	764456 – LD2100/2	Clamp lever CPL., RHS, serrated surface (764454 <i>fine</i>)	
	729970 – LD2078/2	Clamp lever CPL., RHS, serrated surface	
5-C	LD2100/3	Clamp lever CPL., RHS, undulated surface	
6	471117 – LD2006	Bush, Ø=10mm – L=9mm	
7	533023 – LD2010	Plastic plug	
8	333036 – LD2101	Bush	
9	333318 – LD2102	Socket head screw (M4x10)	
10	311208 – LD2014	Nut, M4	
11-A	718862 – LD2103/1	Rapier jaw CPL., RHS, with vulkollan, smooth surface (718865)	
11-B	718863 – LD2103/2	Rapier jaw CPL., RHS, with vulkollan, serrated surface (720406)	
11-B	718864 - LD6014	Rapier jaw CPL., RHS, with vulkollan, fine serrated surface (720406)	
12-A	708855 – LD2058/1	Tungs. Carb. Ins., RHS, CPL, with vulkollan, smooth surface	
12-B	708857 – LD2058/2	Tungs. Carb. Ins., RHS, CPL, with vulkollan, serrated surface	
13-A	471159 – LD2059/1	Tungs. Carb. Ins., RHS, smooth surface	
13-B	471191 – LD2059/2	Tungs. Carb. Ins., RHS, serrated surface	
14	533004 – LD2060	Vulkollan, RHS, 5mm (2,5 x 2,8 x 12,5mm)	
15	LD2104	Rapier jaw body, RHS	
16-A	853179 – LD2105/1	Rapier jaw CPL., RHS, massive smooth surface	
16-B	853245 – LD2105/2	Rapier jaw CPL., RHS, massive serrated surface	
17	LD2106	Rapier jaw CPL., RHS, massive undulated surface	
18	312048 – LD2064	Countersunk screw (M3 x 4)	
19	310943 – LD2065	Hexagon (M3 x 6)	

20	341914 – LD2023	Washer	
21	334069 – LD2025	Guide piece, RHS, harex	
22	334068 – LD2026	Guide piece, LHS, grey	
23	334067 – LD2027	Guide piece, LHS, white	
24	328321 – LD2028	Locking element	
25	711896 – LD2069	Clamping spring CPL., RHS (731082-731082)	
26	707861 – LD2070	Clamping stud, RHS	
27	311206 – LD2022	Nut, M3	
28	309757 – LD2038	Setscrew (M3x16)	
29	309767 – LD2071	Setscrew (M4x4)	
30	711576 – LD2072	Upper guide plate, "Z" form	
31	410826 – LD2033	Lower plate (0,1 x 6 x 14)	
32	322842 – LD2034	Spring (1,1 x 6 x 64mm)	
33	322843 – LD2035	Spring (1,1 x 6 x 50mm)	
34	322844 – LD2036	Spring (1,1 x 6 x 30mm)	
38	853316 – LD2043	Adaptor	
39	490150 – LD2044	Protecting sheet, 10mm	
40	322532 – LD2045	Oval head screw (M4x8)	
41	322502 – LD2046	Oval head screw (M4x25)	
42	322001 – LD2047	Nut, M4	
43	410301 – LD2048	Spring washer	
44	853329 – LD2049	Protecting sheet, 10mm	
45	700155 – LD2050	Sliding piece CPL.	
46	533287 – LD2051	Sliding piece	
47	471398 – LD2052	Tungsten carbide piece	

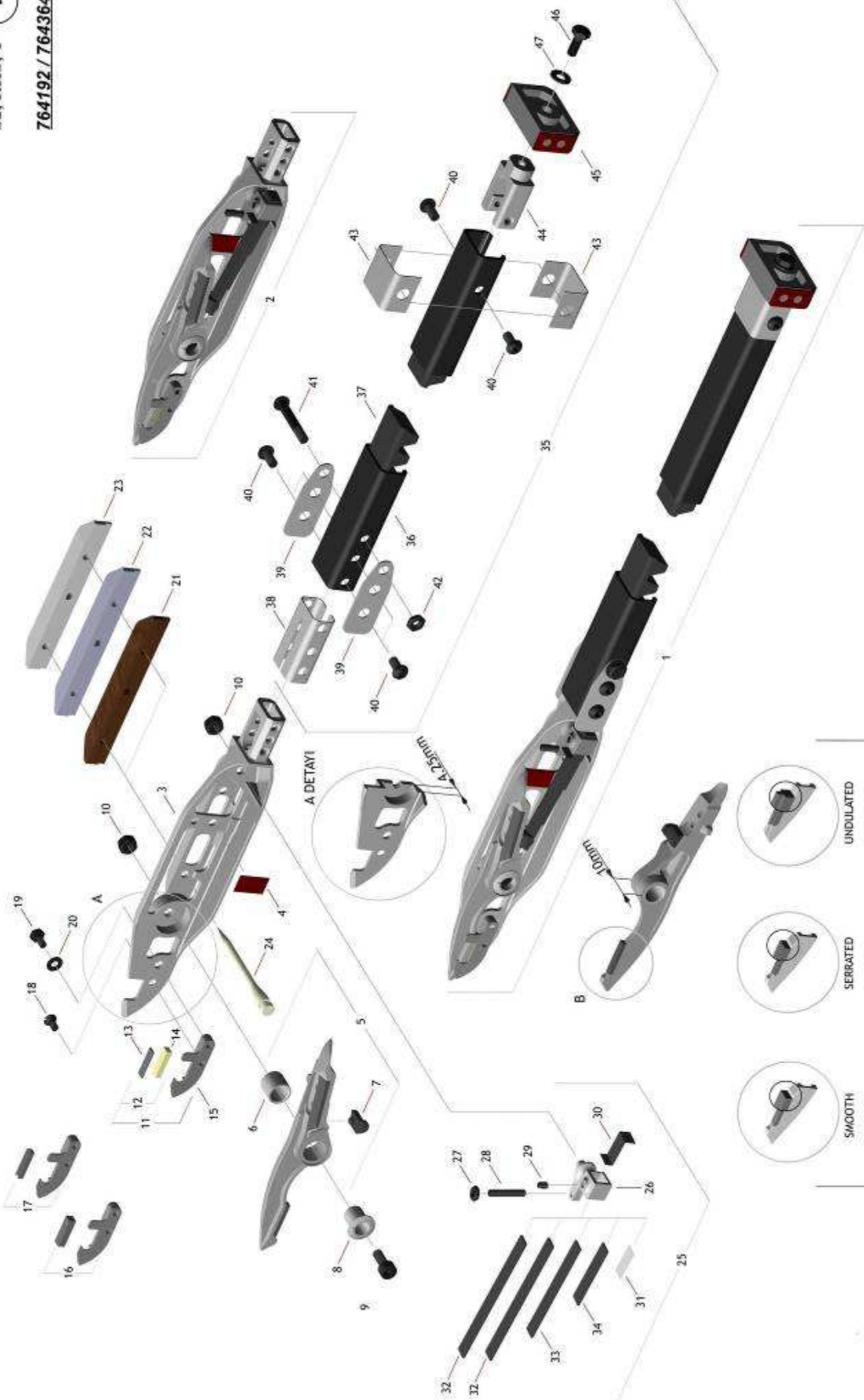

7	ORIGINAL – R.T.S CODES	DESCRIPTION	
1-A	LD2097/1	Rapier CPL., RHS, with vulkollan, smooth surface	
1-B	LD2097/2	Rapier CPL., RHS, with vulkollan, serrated surface	
1-C	LD2097/3	Rapier CPL., RHS, massive smooth surface	
1-D	LD2097/4	Rapier CPL., RHS, massive serrated surface	
1-E	LD2097/5	Rapier CPL., RHS, massive undulated surface	
2-A	764192 – LD2098/1	Rapier head CPL., RHS, with vulkollan, smooth surface	
2-B	764419 – LD2098/2	Rapier head CPL., RHS, with vulkollan, serrated surface	
2-B	764436	Rapier head CPL., RHS, with vulkollan, fine serrated surface	
2-C	LD2098/3	Rapier head CPL., RHS massive smooth surface	
2-D	LD2098/4	Rapier head CPL., RHS massive serrated surface	
2-E	LD2098/5	Rapier head CPL., RHS massive undulated surface	
3	764364 – LD2099	Rapier head body, RHS (<i>with item 4</i>) (<i>716145 short</i>)	
4	328090 – LD2004	Guide plate	
5-A	764293 – LD2100/1	Clamp lever CPL., RHS, smooth surface (<i>790730</i>)	
5-B	764456 – LD2100/2	Clamp lever CPL., RHS, serrated surface (<i>853367 short</i>) (<i>764454 fine</i>)	
5-C	LD2100/3	Clamp lever CPL., RHS, undulated surface	
5-D	764454 - LD6068	Clamp lever CPL., RHS fine serrated	
6	471117 – LD2006	Bush, Ø=10mm – L=9mm	
7	533023 – LD2010	Plastic plug	
8	333036 – LD2101	Bush	
9	333318 – LD2102	Socket head screw (M4x10)	
10	311208 – LD2014	Nut, M4	
11-A	718862 – LD2103/1	Rapier jaw CPL., RHS, with vulkollan, smooth surface (<i>720407</i>)	
11-B	718863 – LD2103/2	Rapier jaw CPL., RHS, with vulkollan, serrated surface (<i>720406</i>)(<i>718864 fine</i>)	
12-A	708855 – LD2058/1	Tungs. Carb. Ins., RHS, CPL, with vulkollan, smooth surface	
12-B	708857 – LD2058/2	Tungs. Carb. Ins., RHS, CPL, with vulkollan, serrated surface	
13-B	708859 - LD6020	Tungs. Carb. Ins., RHS, CPL, with vulkollan, fine serrated surface	
13-A	471159 – LD2059/1	Tungs. Carb. Ins., RHS, smooth surface	
13-B	471191 – LD2059/2	Tungs. Carb. Ins., RHS, serrated surface	
14	533004 – LD2060	Vulkollan, RHS, 5mm (2,5 x 2,8 x 12,5mm)	
15	LD2104	Rapier jaw body, RHS	
16-A	853179 – LD2105/1	Rapier jaw CPL., RHS, massive smooth surface	
16-B	853245 – LD2105/2	Rapier jaw CPL., RHS, massive serrated surface	
17	LD2106	Rapier jaw CPL., RHS, massive undulated surface	
18	312048 – LD2064	Countersunk screw (M3 x 4)	
19	310943 – LD2065	Hexagon (M3 x 6)	

20	341914 – LD2023	Washer	
21	334069 – LD2025	Guide piece, LHS, harex	
22	334068 – LD2026	Guide piece, LHS, grey	
23	334067 – LD2027	Guide piece, LHS, white	
24	328321 – LD2028	Locking element	
25	711896 – LD2069	Clamping spring CPL., RHS (731082-731082)	
26	707861 – LD2070	Clamping stud, RHS	
27	311206 – LD2022	Nut, M3	
28	309757 – LD2038	Setscrew (M3x16)	
29	309767 – LD2071	Setscrew (M4x4)	
30	711576 – LD2072	Upper guide plate, "Z" form	
31	410826 – LD2033	Lower plate (0,1 x 6 x 14)	
32	322842 – LD2034	Spring (1,1 x 6 x 64mm)	
33	322843 – LD2035	Spring (1,1 x 6 x 50mm)	
34	322844 – LD2036	Spring (1,1 x 6 x 30mm)	
38	853316 – LD2043	Adaptor	
39	490150 – LD2044	Protecting sheet, 10mm	
40	322532 – LD2045	Oval head screw (M4x8)	
41	322502 – LD2046	Oval head screw (M4x25)	
42	322001 – LD2047	Nut, M4	
43	853329 – LD2049	Protecting sheet, 10mm	
44	334982 – LD2094	Stop piece, 10mm, "U" form	
45	339317 – LD2095	Guide piece, 10mm	
46	311066 – LD2096	Hexagon screw (M4x10)	
47	410301 – LD2048	Spring washer	

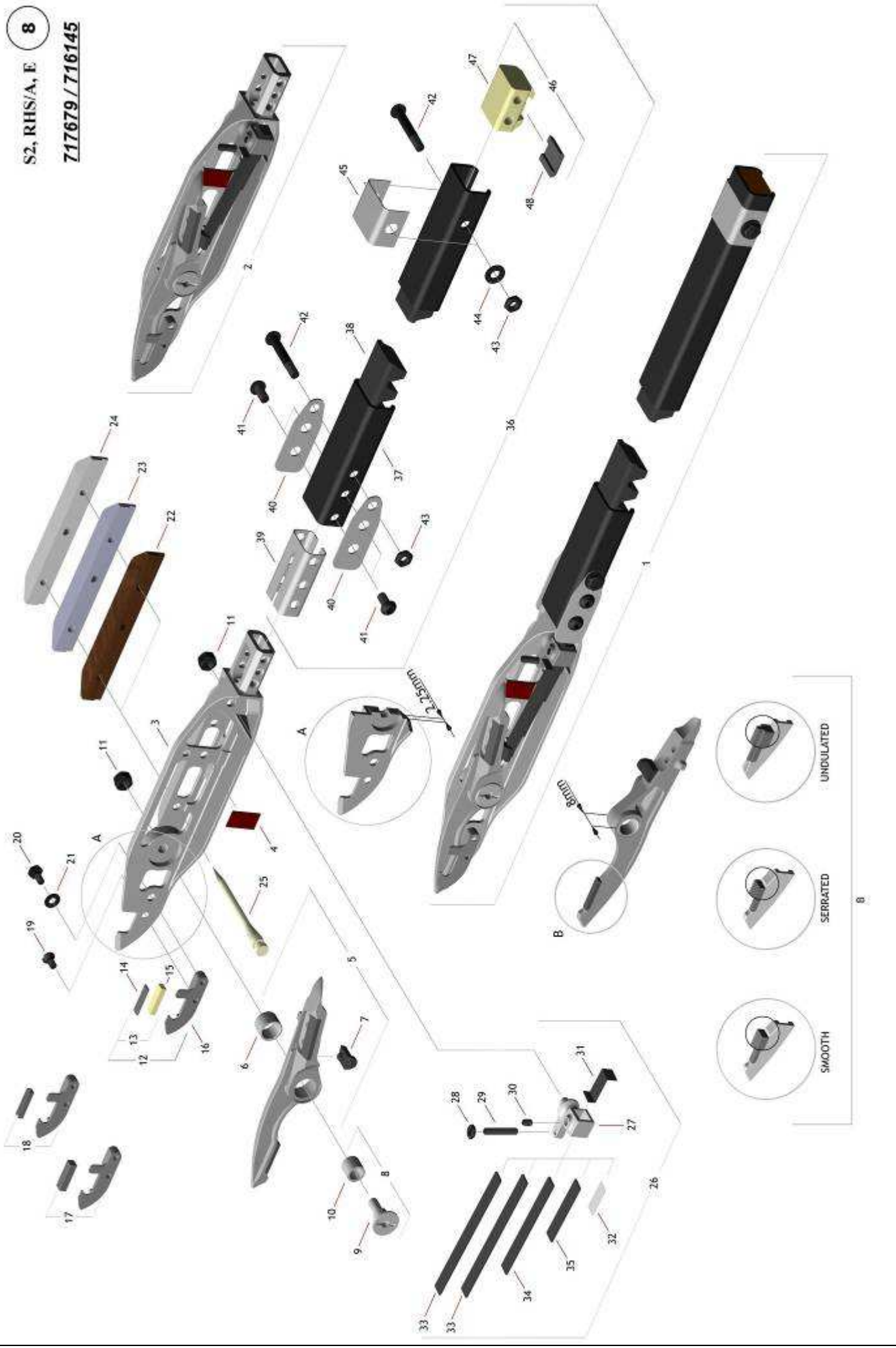

8	ORIGINAL – R.T.S CODES	DESCRIPTION	
1-A	LD2237/1	Rapier CPL., RHS, with vulkollan, smooth surface	
1-B	LD2237/2	Rapier CPL., RHS, with vulkollan, serrated surface	
1-C	LD2237/3	Rapier CPL., RHS, massive smooth surface	
1-D	LD2237/4	Rapier CPL., RHS, massive serrated surface	
1-E	LD2237/5	Rapier CPL., RHS, massive undulated surface	
2-A	717659 – LD2114/1	Rapier head CPL., LHS, with vulkollan, smooth surface	
2-B	717679 – LD2114/2	Rapier head CPL., RHS, with vulkollan, serrated surface	
2-C	717669 – LD2114/3	Rapier head CPL., RHS massive smooth surface	
2-D	717689 – LD2114/4	Rapier head CPL., RHS massive serrated surface	
2-E	LD2114/5	Rapier head CPL., RHS massive undulated surface	
3	716145 – LD2115	Rapier head body, RHS (<i>with item 4</i>)	
4	328090 – LD2004	Guide plate	
5-A	729968 – LD2078/1	Clamp lever CPL., RHS, short, smooth surface (790730)	
5-B	709970 – LD2078/2	Clamp lever CPL., RHS, serrated surface	
5-C	LD2078/3	Clamp lever CPL., RHS, undulated surface	
6	471117 – LD2006	Bush, Ø=10mm – L=9mm	
7	533023 – LD2010	Plastic plug	
8	LD2107	Bearing stud with bush	
9	714144 – LD2108	Bearing stud without bush	
10	325230 – LD2109	Bush, Ø8 x 7,2mm	
11	311208 – LD2014	Nut, M4	
12-A	718862 – LD2103/1	Rapier jaw CPL., RHS, with vulkollan, smooth surface	
12-B	718863 – LD2103/2	Rapier jaw CPL., RHS, with vulkollan, serrated surface	
12-A	708855 – LD2058/1	Tungs. Carb. Ins., RHS, CPL, with vulkollan, smooth surface	
13-B	708857 – LD2058/2	Tungs. Carb. Ins., RHS, CPL, with vulkollan, serrated surface	
14-A	471159 – LD2059/1	Tungs. Carb. Ins., RHS, smooth surface	
14-B	471191 – LD2059/2	Tungs. Carb. Ins., RHS, serrated surface	
15	533004 – LD2060	Vulkollan, RHS, 5mm (2,5 x 2,8 x 12,5mm)	
16	LD2104	Rapier jaw body, RHS	
17-A	853179 – LD2105/1	Rapier jaw CPL., RHS, massive smooth surface	
17-B	853245 – LD2105/2	Rapier jaw CPL., RHS, massive serrated surface	
18	LD2106	Rapier jaw CPL., RHS, massive undulated surface	
19	312048 – LD2064	Countersunk screw (M3 x 4)	
20	310943 – LD2065	Hexagon (M3 x 6)	
21	341914 – LD2023	Washer	
22	334069 – LD2025	Guide piece, LHS, harex	

23	334068 – LD2026	Guide piece, LHS, grey	
24	328321 – LD2028	Locking element	
25	328321 – LD2028	Locking element	
26	711896 – LD2069	Clamping spring CPL., RHS (731082-731082)	
27	707861 – LD2070	Clamping stud, RHS	
28	311206 – LD2022	Nut, M3	
29	309757 – LD2038	Setscrew (M3x16)	
30	309767 – LD2071	Setscrew (M4x4)	
31	711576 – LD2072	Upper guide plate, “Z” form	
32	410826 – LD2033	Lower plate (0,1 x 6 x 14)	
33	322842 – LD2034	Spring (1,1 x 6 x 64mm)	
34	322843 – LD2035	Spring (1,1 x 6 x 50mm)	
35	322844 – LD2036	Spring (1,1 x 6 x 30mm)	
39	853316 – LD2043	Adaptor	
40	490150 – LD2044	Protecting sheet, 10mm	
41	322532 – LD2045	Oval head screw (M4x8)	
42	322502 – LD2046	Oval head screw (M4x25)	
43	322001 – LD2047	Nut, M4	
44	410301 – LD2048	Spring washer	
45	853329 – LD2049	Protecting sheet, 10mm	
46	700155 – LD2050	Sliding piece CPL.	
47	533287 – LD2051	Sliding piece	
48	471398 – LD2052	Tungsten carbide piece	

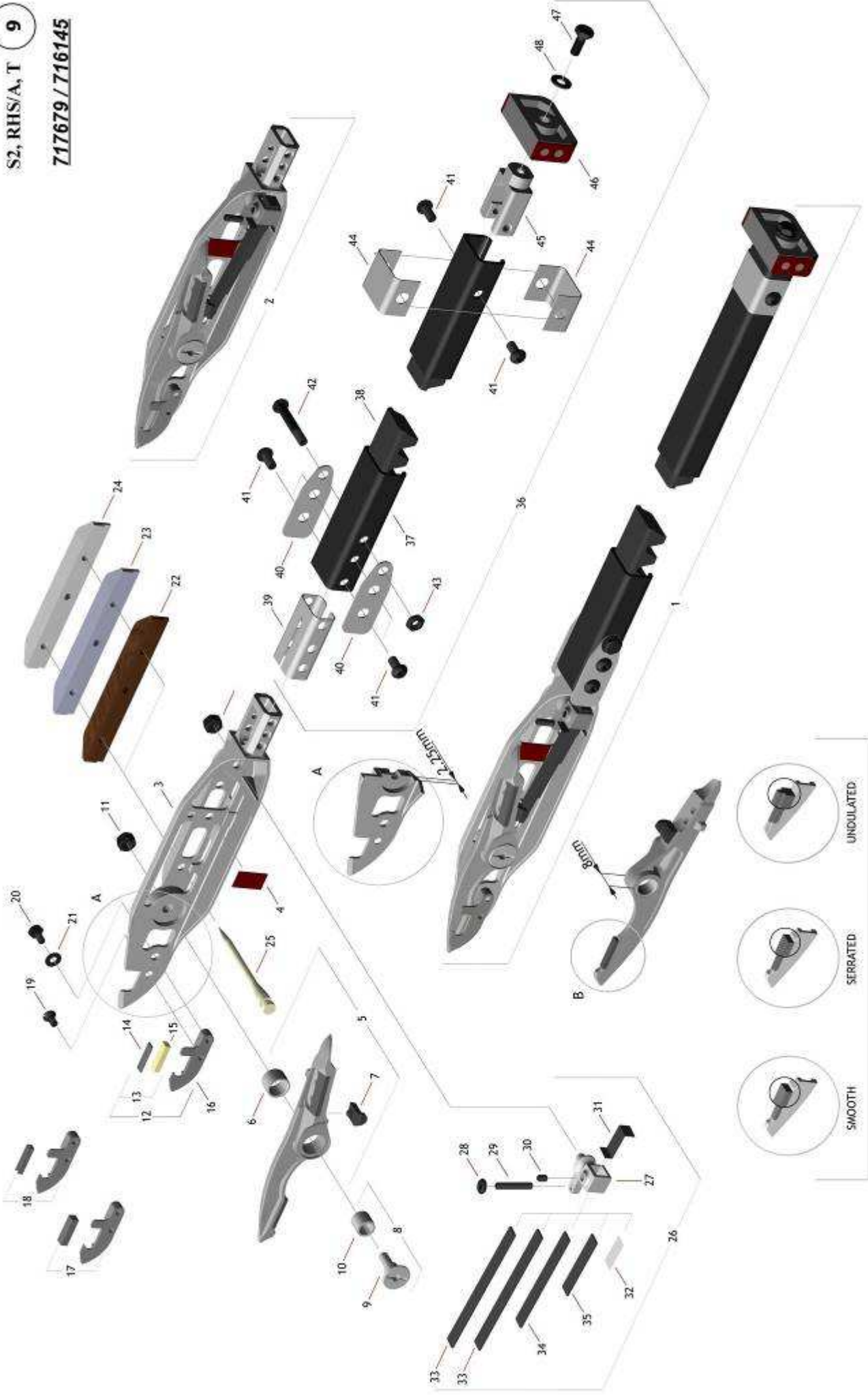

9	ORIGINAL – R.T.S CODES	DESCRIPTION	
1-A	LD2150/1	Rapier CPL., RHS, with vulkollan, smooth surface	
1-B	LD2150/2	Rapier CPL., RHS, with vulkollan, serrated surface	
1-C	LD2150/3	Rapier CPL., RHS, massive smooth surface	
1-D	LD2150/4	Rapier CPL., RHS, massive serrated surface	
1-E	LD2150/5	Rapier CPL., RHS, massive undulated surface	
2-A	717659 – LD2114/1	Rapier head CPL., LHS, with vulkollan, smooth surface	
2-B	717679 – LD2114/2	Rapier head CPL., RHS, with vulkollan, serrated surface	
2-C	717669 – LD2114/3	Rapier head CPL., RHS massive smooth surface	
2-D	717689 – LD2114/4	Rapier head CPL., RHS massive serrated surface	
2-E	LD2114/5	Rapier head CPL., RHS massive undulated surface	
3	716145 – LD2115	Rapier head body, RHS (<i>with item 4</i>)	
4	328090 – LD2004	Guide plate	
5-A	729968 – LD2078/1	Clamp lever CPL., RHS, short, smooth surface (790730)	
5-B	709970 – LD2078/2	Clamp lever CPL., RHS, serrated surface	
5-C	LD2078/3	Clamp lever CPL., RHS, undulated surface	
6	471117 – LD2006	Bush, Ø=10mm – L=9mm	
7	533023 – LD2010	Plastic plug	
8	LD2107	Bearing stud with bush	
9	714144 – LD2108	Bearing stud without bush	
10	325230 – LD2109	Bush, Ø8mm – L=7,2mm	
11	311208 – LD2014	Nut, M4	
12-A	718862 – LD2103/1	Rapier jaw CPL., RHS, with vulkollan, smooth surface	
12-B	718863 – LD2103/2	Rapier jaw CPL., RHS, with vulkollan, serrated surface	
13-A	708855 – LD2058/1	Tungs. Carb. Ins., RHS, CPL, with vulkollan, smooth surface	
13-B	708857 – LD2058/2	Tungs. Carb. Ins., RHS, CPL, with vulkollan, serrated surface	
14-A	471159 – LD2059/1	Tungs. Carb. Ins., RHS, smooth surface	
14-B	471191 – LD2059/2	Tungs. Carb. Ins., RHS, serrated surface	
15	533004 – LD2060	Vulkollan, RHS, 5mm (2,5 x 2,8 x 12,5mm)	
16	LD2104	Rapier jaw body, RHS	
17-A	853179 – LD2105/1	Rapier jaw CPL., RHS, massive smooth surface	
17-B	853245 – LD2105/2	Rapier jaw CPL., RHS, massive serrated surface	
18	LD2106	Rapier jaw CPL., RHS, massive undulated surface	
19	312048 – LD2064	Countersunk screw (M3 x 4)	
20	310943 – LD2065	Hexagon (M3 x 6)	
21	341914 – LD2023	Washer	
22	337910 – LD2024	Countersunk screw (M3 x 6)	

23	334069 – LD2025	Guide piece, LHS, harex	
24	334068 – LD2026	Guide piece, LHS, grey	
25	328321 – LD2028	Locking element	
26	711896 – LD2069	Clamping spring CPL., RHS (731082-731082)	
27	707861 – LD2070	Clamping stud, RHS	
28	311206 – LD2022	Nut, M3	
29	309757 – LD2038	Setscrew (M3x16)	
30	309767 – LD2071	Setscrew (M4x4)	
31	711576 – LD2072	Upper guide plate, "Z" form	
32	410826 – LD2033	Lower plate (0,1 x 6 x 14)	
33	322842 – LD2034	Spring (1,1 x 6 x 64mm)	
34	322843 – LD2035	Spring (1,1 x 6 x 50mm)	
35	322844 – LD2036	Spring (1,1 x 6 x 30mm)	
39	853316 – LD2043	Adaptor	
40	490150 – LD2044	Protecting sheet, 10mm	
41	322532 – LD2045	Oval head screw (M4x8)	
42	322502 – LD2046	Oval head screw (M4x25)	
43	322001 – LD2047	Nut, M4	
44	853329 – LD2049	Protecting sheet, 10mm	
45	334982 – LD2094	Stop piece, 10mm, "U" form	
46	339317 – LD2095	Guide piece, 10mm	
47	311066 – LD2096	Hexagon screw (M4x10)	
48	410301 – LD2048	Spring washer	

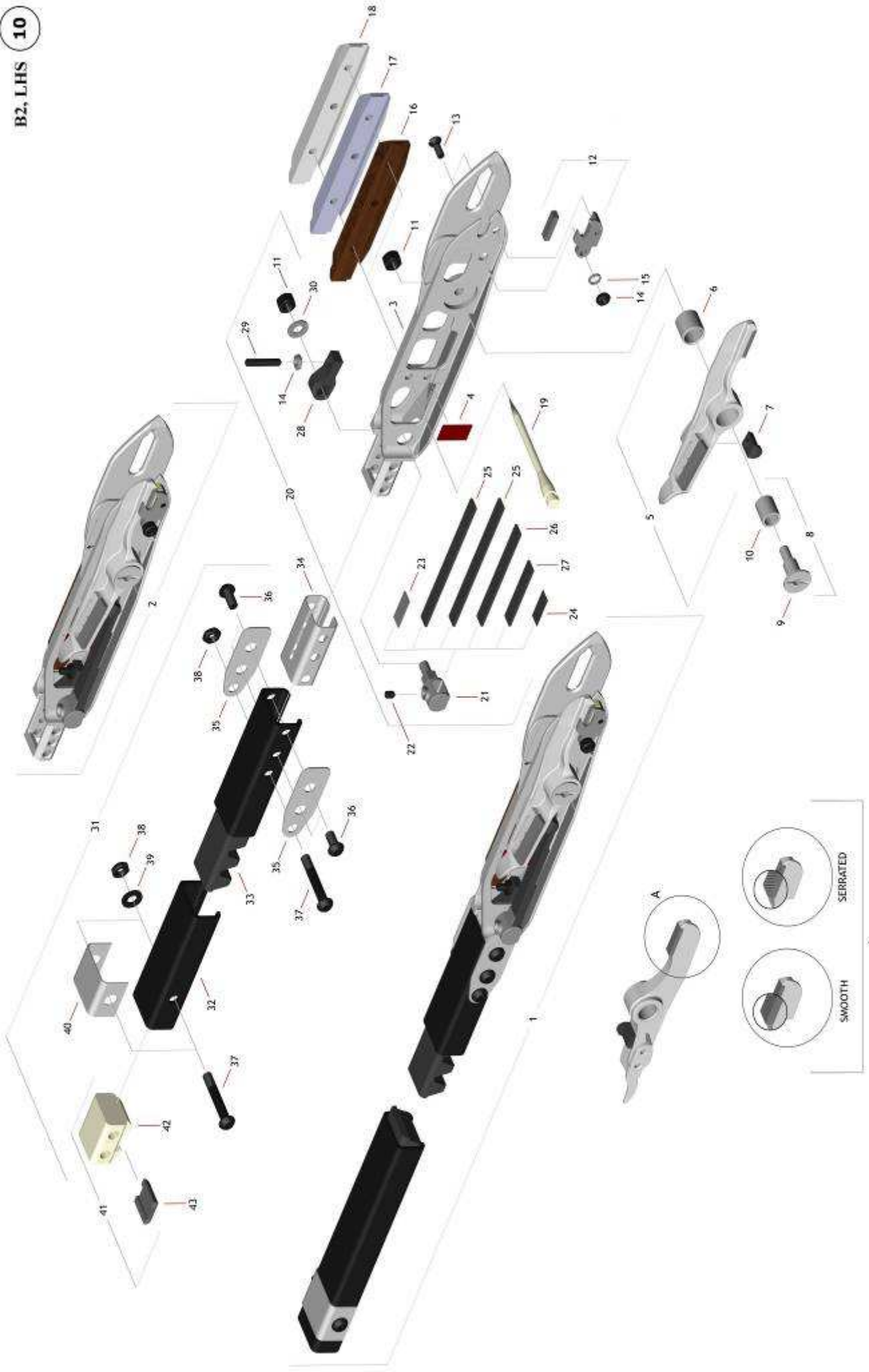

10	ORIGINAL – R.T.S CODES	DESCRIPTION	
1-A	LD2110/1	Rapier CPL., LHS, with vulkollan, smooth surface	
1-B	LD2110/2	Rapier CPL., LHS, with vulkollan, serrated surface	
2-A	LD2111/1	Rapier head CPL., LHS, with vulkollan, smooth surface	
2-B	LD2111/1	Rapier head CPL., LHS, with vulkollan, serrated surface	
3	LD2112	Rapier head body, LHS	
4	328090 – LD2004	Guide plate	
5-A	LD2113/1	Clamp lever CPL., LHS, smooth surface	
5-B	LD2113/2	Clamp lever CPL., LHS, serrated surface	
6	471117 – LD2006	Bush, Ø=10mm – L=9mm	
7	533023 – LD2010	Plastic plug	
8	LD2011	Bearing stud with bush	
9	711900 – LD2012	Bearing stud without bush	
10	471118 – LD2013	Bush, Ø=8mm – L=9,2mm	
11	311208 – LD2014	Nut, M4	
12-A	LD2077/1	Rapier jaw CPL., LHS, massive smooth surface	
12-B	853296 – LD2077/2	Rapier jaw CPL., LHS, massive serrated surface	
13	337910 – LD2024	Countersunk screw (M3 x 6)	
14	311206 – LD2022	Nut, M3	
15	341914 – LD2023	Washer	
16	333448 – LD2066	Guide piece, LHS, harex (335507)	
17	333449 – LD2067	Guide piece, LHS, grey	
18	343450 – LD2068	Guide piece, LHS, white	
19	328321 – LD2028	Locking element	
20	711895 – LD2029	Clamping spring CPL., LHS	
21	707873 – LD2030	Clamping stud, LHS	
22	309758 – LD2031	Setscrew (M3x4)	
23	711576 – LD2032	Upper guide plate (0,5 x 6 x 14mm)	
24	410826 – LD2033	Lower guide plate (0,1 x 6 x 14mm)	
25	322842 – LD2034	Spring (1,1 x 6 x 64mm)	
26	322843 – LD2035	Spring (1,1 x 6 x 50mm)	
27	322844 – LD2036	Spring (1,1 x 6 x 30mm)	
28	769850 – LD2037	Stop piece, LHS	
29	LD2038	Setscrew (M3x16)	
30	301702 – LD2039	Washer	
34	853316 – LD2043	Adaptor	
35	490150 – LD2044	Protecting sheet, 10mm	

36	322532 – LD2045	Oval head screw (M4x8)	
37	322502 – LD2046	Oval head screw (M4x25)	
38	322001 – LD2047	Nut, M4	
39	410301 – LD2048	Spring washer	
40	853329 – LD2049	Protecting sheet, 10mm	
41	700155 – LD2050	Sliding piece CPL.	
42	533287 – LD2051	Sliding piece	
43	471398 – LD2052	Tungsten carbide piece	

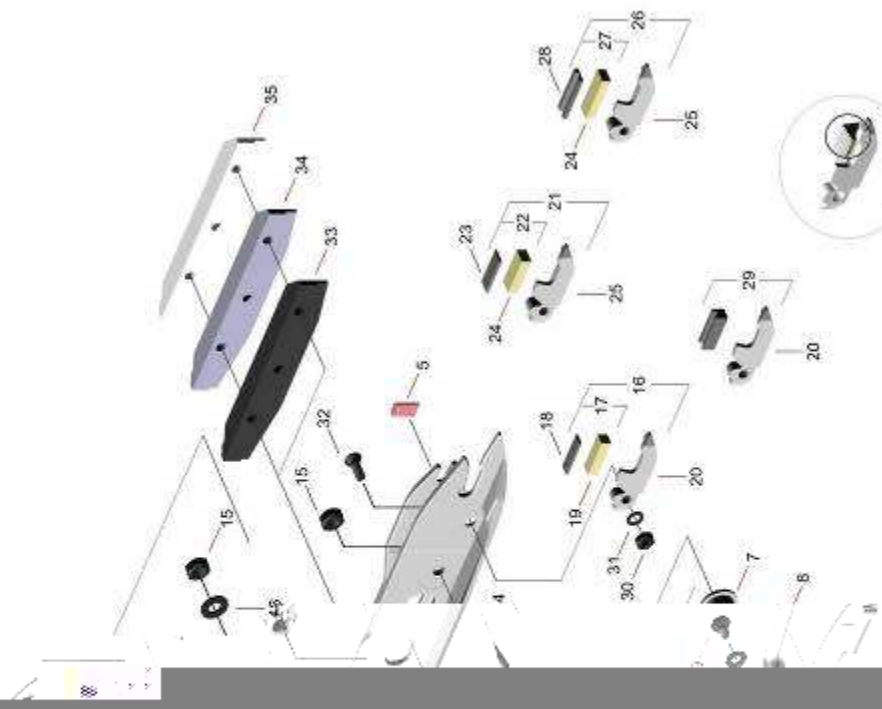

LENGTHWAYS GROOVED

11	ORIGINAL – R.T.S CODES	DESCRIPTION	
1-A	70244Hce – LD2116/1	Rapier CPL., LHS, with vulkollan, smooth surface, ceramic	
1-B	70244Hcr – LD2116/2	Rapire CPL., LHS, with vulkollan, smooth surface, chrome	
1-C	70426Yce – LD2116/3	Rapier CPL., LHS, with vulkollan, serrated surface, ceramic	
1-D	70426Ycr – LD2116/4	Rapier CPL., LHS, with vulkollan, serrated surface, chrome	
1-E	LD2116/5	Rapier CPL., LHS, with vulkollan, lengthways grooved surface, ceramic	
1-F	LD2116/6	Rapier CPL., LHS, with vulkollan, lengthways grooved surface, chrome	
1-G	LD2116/7	Rapier CPL., LHS, with vulkollan, smooth surface, 5mm, ceramic	
1-H	LD2116/8	Rapier CPL., LHS, with vulkollan, smooth surface, 5mm, chrome	
1-I	LD2116/9	Rapier CPL., LHS, with vulkollan, serrated surface, 5mm, ceramic	
1-J	LD2116/10	Rapier CPL., LHS, with vulkollan, serrated surface, 5mm, chrome	
1-K	LD2116/11	Rapier CPL., LHS, with vulkollan, lengthways grooved surface, 5mm, ceramic	
1-L	LD2116/12	Rapier CPL., LHS, with vulkollan, lengthways grooved surface, 5mm, chrome	
1-M	LD2116/13	Rapier CPL., LHS, with vulkollan, split smooth surface, 5mm, ceramic	
1-N	LD2116/14	Rapier CPL., LHS, with vulkollan, split smooth surface, 5mm, chrome	
1-O	LD2116/15	Rapier CPL., LHS, with vulkollan, split serrated surface, 5mm, ceramic	
1-P	LD2116/16	Rapier CPL., LHS, with vulkollan, split serrated surface, 5mm, chrome	
1-R	LD2116/17	Rapier CPL., LHS, with vulkollan, split lengthways grooved surface, 5mm, ceramic	
1-S	LD2116/18	Rapier CPL., LHS, with vulkollan, split lengthways grooved surface, 5mm, chrome	
1-T	LD2116/19	Rapier CPL., LHS, massive undulated surface, ceramic	
1-U	LD2116/20	Rapier CPL., LHS, massive undulated surface, chrome	
2-A	70133Xce – LD2117/1	<u>Original</u> Rapier head CPL., LHS, with vulkollan, smooth surface, ceramic (785173)	
2-B	70133Xcr – LD2117/2	Rapier head CPL., LHS, with vulkollan, smooth surface, chrome	
2-C	70218Sce – LD2117/3	<u>Original</u> Rapier head CPL., LHS, with vulkollan, serrated surface, ceramic (70427B fine)	
2-D	70218Scr – LD2117/4	Rapier head CPL., LHS, with vulkollan, serrated surface, chrome (70427B fine)	
2-E	70134Ace – LD2117/5	<u>Original</u> Rapier head CPL., LHS, with vulkollan, lengthways grooved surface, ceramic	
2-F	70134Acr – LD2117/6	Rapier head CPL., LHS, with vulkollan, lengthways grooved surface, chrome	
2-G	LD2117/7	<u>Original</u> Rapier head CPL., LHS, with vulkollan, smooth surface, 5mm, ceramic	
2-H	LD2117/8	Rapier head CPL., LHS, with vulkollan, smooth surface, 5mm, chrome	
2-I	LD2117/9	<u>Original</u> Rapier head CPL., LHS, with vulkollan, serrated surface, 5mm, ceramic	
2-J	LD2117/10	Rapier head CPL., LHS, with vulkollan, serrated surface, 5mm, chrome	
2-K	LD2117/11	<u>Original</u> Rapier head CPL., LHS, with vulkollan, lengthways grooved surface, 5mm, ceramic	
2-L	LD2117/12	Rapier head CPL., LHS, with vulkollan, lengthways grooved surface, 5mm, chrome	
2-M	LD2117/13	<u>Original</u> Rapier head CPL., LHS, with vulkollan, split smooth surface, 5mm, ceramic	

2-N	LD2117/14	Rapier head CPL., LHS, with vulkollan, split smooth surface, 5mm, chrome	
2-O	LD2117/15	<u>Original</u> Rapier head CPL., LHS, with vulkollan, split serrated surface, 5mm, ceramic	
2-P	LD2117/16	Rapier head CPL., LHS, with vulkollan, split serrated surface, 5mm, chrome	
2-R	LD2117/17	<u>Original</u> Rapier head CPL., LHS, with vulkollan, split lengthways grooved surface, 5mm, ceramic	
2-S	LD2117/18	Rapier head CPL., LHS, with vulkollan, split lengthways grooved surface, 5mm, chrome	
2-T	LD2117/19	<u>Original</u> Rapier head CPL., LHS, massive undulated surface, ceramic	
2-U	LD2117/20	Rapier head CPL., LHS, massive undulated surface, chrome	
3-A	70758Kce – LD2118/1	<u>Original</u> Rapier head body, LHS, 8mm, ceramic	
3-B	70365Ycr – LD2118/2	Rapier head body, LHS, 8mm, chrome	
4	334554 – LD2119	Centring washer	
5	450171 – LD2120	Ceramic piece	
6-A	70388D – LD2121/1	Clamp lever CPL., LHS, smooth surface (785813)	
6-B	70218R – LD2121/2	Clamp lever CPL., LHS, serrated surface (70412R fine)	
6-C	LD2121/3	Clamp lever CPL., LHS, smooth surface, 5mm	
6-D	LD2121/4	Clamp lever CPL., LHS, serrated surface, 5mm	
6-E	LD2121/5	Clamp lever CPL., LHS, split, smooth surface, 5mm	
6-F	LD2121/6	Clamp lever CPL., LHS, split, serrated surface, 5mm	
6-G	LD2121/7	Clamp lever CPL., LHS, undulated surface	
7	LD2122	Centring bush	
8	767894 – LD2007	Line feed lever	
9	311179 – LD2008	Hexhagon screw (M3x4)	
10	301701 – LD2009	Washer	
11	342799 – LD2123	Vulkollan guide	
12	533023 – LD2010	Plastic plug	
13	333036 – LD2101	Bush	
14	333318 – LD2102	Socket head screw (M4x10)	
15	311208 – LD2014	Nut, M4	
16-A	785172 – LD2124/1	Rapier jaw CPL., LHS, with vulkollan, smooth surface	
16-B	70218P – LD2124/2	Rapier jaw CPL., LHS, with vulkollan, serrated surface	
	787582 - LD6017	Rapier jaw CPL., LHS, with vulkollan, fine serrated surface	
16-C	LD2124/3	Rapier jaw CPL., LHS, with vulkollan, lengthways grooved surface	
17-A	765150 – LD2125/1	Tungs. Carb. Ins., LHS, CPL, with vulkollan, smooth surface	
17-B	765276 – LD2125/2	Tungs. Carb. Ins., LHS, CPL, with vulkollan, serrated surface (765271 fine)	
17-C	LD2125/3	Tungs. Carb. Ins., LHS, CPL, with vulkollan, lengthways grooved surface	
18-A	471160 – LD2017/1	Tungs. Carb. Ins., LHS, smooth surface	
18-B	471196 – LD2017/2	Tungs. Carb. Ins., LHS, serrated surface	
18-C	LD2017/3	Tungs. Carb. Ins., LHS, lengthways grooved surface	

19	334421 – LD2126	Vulkollan, LHS, 5mm (3,8 x 3,8 x 12,5mm)	
20	LD2127	Rapier jaw body, LHS	
21-A	71199G – LD2128/1	Rapier jaw CPL., LHS, with vulkollan, smooth surface, 5mm	
21-B	71199K – LD2128/2	Rapier jaw CPL., LHS, with vulkollan, serrated surface, 5mm	
21-C	72544R – LD2128/3	Rapier jaw CPL., LHS, with vulkollan, lengthways grooved surface, 5mm	
22-A	70688C – LD2129/1	Tungs. Carb. Ins., LHS, CPL, with vulkollan, smooth surface, 5mm	
22-B	70687Y – LD2129/2	Tungs. Carb. Ins., LHS, CPL, with vulkollan, serrated surface, 5mm	
22-C	72544P – LD2129/3	Tungs. Carb. Ins., LHS, CPL, with vulkollan, lengthways grooved surface, 5mm (70687V)	
23-A	342823 – LD2130/1	Tungs. Carb. Ins., LHS, CPL, smooth surface, 5mm	
23-B	342825 – LD2130/2	Tungs. Carb. Ins., LHS, CPL, serrated surface, 5mm	
23-C	348714 – LD2130/3	Tungs. Carb. Ins., LHS, CPL, lengthways surface, 5mm	
24	342827 – LD2131	Vulkollan, LHS (3,5 x 5 x 15,5mm)	
25	LD2132	Rapier jaw body, LHS, 5mm	
26-A	LD2133/1	Rapier jaw CPL., LHS, with vulkollan, split smooth surface, 5mm	
26-B	LD2133/2	Rapier jaw CPL., LHS, with vulkollan, split serrated surface, 5mm	
26-C	LD2133/3	Rapier jaw CPL., LHS, with vulkollan, split lengthways grooved surface, 5mm	
27-A	LD2134/1	Tungs. Carb. Ins., LHS, CPL, with vulkollan, split smooth surface, 5mm	
27-B	LD2134/2	Tungs. Carb. Ins., LHS, CPL, with vulkollan, split serrated surface, 5mm	
27-C	LD2134/3	Tungs. Carb. Ins., LHS, CPL, with vulkollan, split lengthways grooved surface, 5mm	
28-A	LD2135/1	Tungs. Carb. Ins., LHS, CPL, with vulkollan, split smooth surface, 5mm	
28-B	LD2135/2	Tungs. Carb. Ins., LHS, CPL, with vulkollan, split serrated surface, 5mm	
28-C	LD2135/3	Tungs. Carb. Ins., LHS, CPL, with vulkollan, split lengthways grooved surface, 5mm	
29	LD2136	Rapier jaw CPL., LHS, massive undulated surface	
30	311206 – LD2022	Nut, M3	
31	341914 – LD2023	Washer	
32	337910 – LD2024	Countersunk screw (M3 x 6)	
33	338924 – LD2137	Guide piece, LHS, black	
34	338287 – LD2138	Guide piece, LHS, grey	
35	335603 – LD2139	Guide piece, LHS, light grey	
36	328321 – LD2028	Locking element	
37	70225E – LD2140	Clamping spring CPL., LHS	
38	707873 – LD2030	Clamping stud, LHS	
39	309758 – LD2031	Setscrew (M3x4)	
40	711576 – LD2032	Upper guide plate	
41	410826 – LD2033	Lower guide plate (0,1 x 6 x 14mm)	
42	345444 – LD2141	Vulkollan guide	

43	322842 – LD2034	Spring (1,1 x 6 x 64mm) (72026V with vulkollan)	
44	322843 – LD2035	Spring (1,1 x 6 x 50mm)	
45	322844 – LD2036	Spring (1,1 x 6 x 30mm)	
46	769850 – LD2037	Stop piece, LHS (338924)	
47	339588 – LD2142	Oval head screw (M3x10)	
48	301702 – LD2039	Washer	
49	70064H – LD2143	Carbon profile CPL., 8mm	
50	70560M – LD2144	Carbon profile, 8mm	
51	70056A – LD2145	Toothed rack, 8mm (70055W)	
52	335096 – LD2146	Fitting piece, “Y” form, 8mm	
53	70262T – LD2127	Side plate (21x1,5x9)	
54	335102 – LD2148	Oval head screw (M4x10)	
55	322502 – LD2046	Oval head screw (M4x25) (70088B)	
56	322001 – LD2047	Nut, M4 (325795)	
57	410301 – LD2048	Spring washer	
58	70045H – LD2149	Protecting sheet, 8mm	
59	322532 – LD2045	Oval head screw (M4x8)	
60	338657 – LD2151	Stop piece, “U” form, 8mm	
61	339317 – LD2152	Guide piece	
62	311066 – LD2096	Hexagon screw (M4x10)	

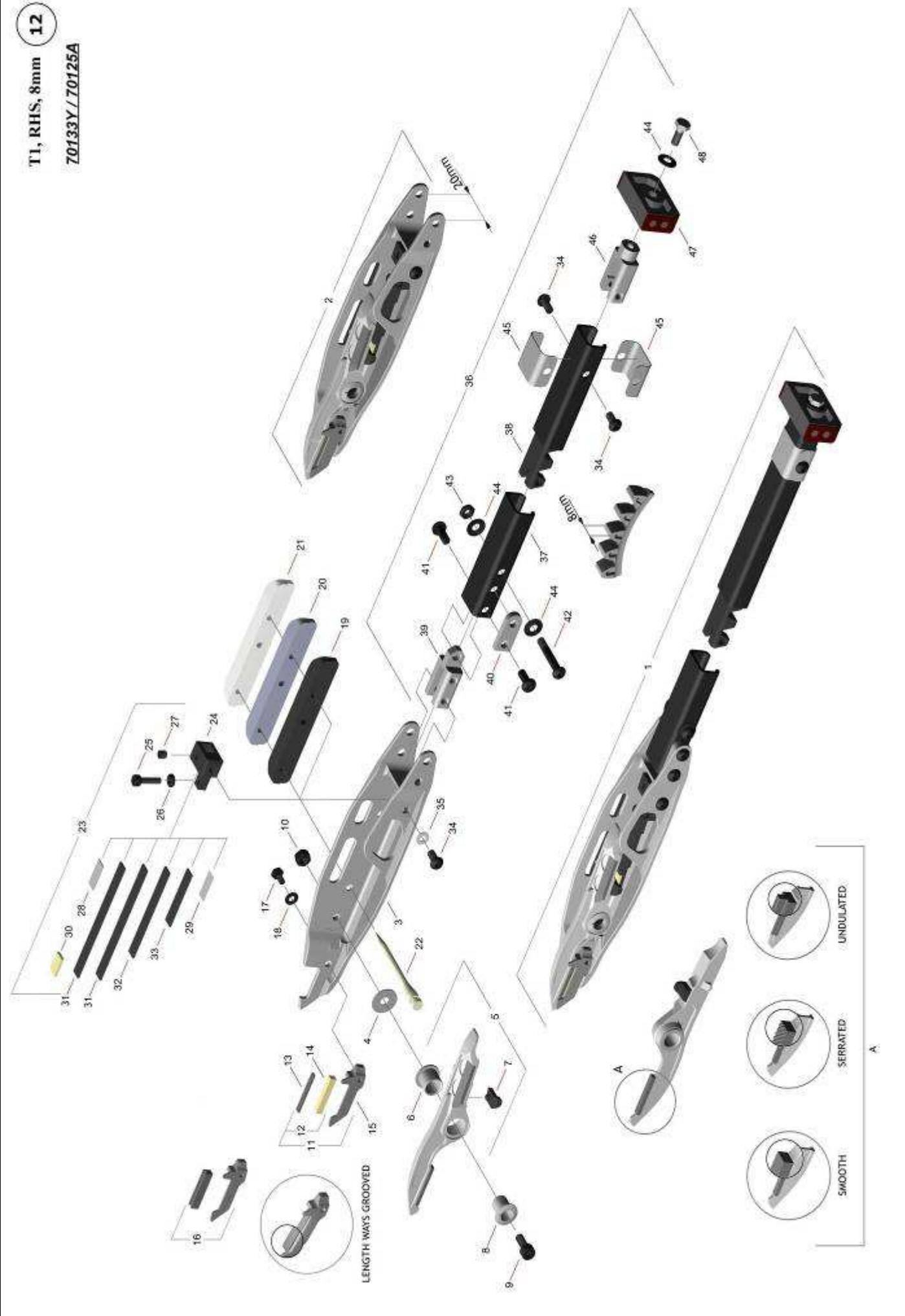

LENGTHWAYS GROOVED

- SMOOTH
- SERRATED
- UNDULATED

A

12	ORIGINAL – R.T.S CODES	DESCRIPTION	
1-A	70244Kce – LD2153/1	Rapier CPL., RHS, with vulkollan, smooth surface, ceramic	
1-B	70244Kcr – LD2153/2	Rapier CPL., RHS, with vulkollan, smooth surface, chrome	
1-C	70427Ace – LD2153/3	Rapier CPL., RHS, with vulkollan, serrated surface, ceramic (70427Cce fine)	
1-D	70427Acr – LD2153/4	Rapier CPL., RHS, with vulkollan, serrated surface, chrome (70427Ccr fine)	
1-E	LD2153/5	Rapier CPL., RHS, with vulkollan, lengthways grooved surface, ceramic	
1-F	LD2153/6	Rapier CPL., RHS, with vulkollan, lengthways grooved surface, chrome	
1-G	LD2153/7	Rapier CPL., RHS, massive undulated surface, ceramic	
1-H	LD2153/8	Rapier CPL., RHS, massive undulated surface, chrome	
2-A	70133Yce – LD2154/1	<u>Original</u> Rapier head CPL., RHS, with vulkollan, smooth surface, ceramic (785138)	
2-B	70133Ycr – LD2154/2	Rapier head CPL., RHS, with vulkollan, smooth surface, chrome	
2-C	70218Kce – LD2154/3	<u>Original</u> Rapier head CPL., RHS, with vulkollan, serrated surface, ceramic (70133Wce fine)	
2-C	70133W – LD6092	Rapier head CPL., RHS, with vulkollan, fine serrated surface, ceramic	
2-D	70218Kcr – LD2154/4	Rapier head CPL., RHS, with vulkollan, serrated surface, chrome (70133Wcr fine)	
2-E	LD2154/5	<u>Original</u> Rapier head CPL., RHS, with vulkollan, lengthways grooved surface, ceramic	
2-F	LD2154/6	Rapier head CPL., RHS, with vulkollan, lengthways grooved surface, chrome	
2-G	LD2154/7	<u>Original</u> Rapier head CPL., RHS, massive undulated surface, ceramic	
2-H	LD2154/8	Rapier head CPL., RHS, massive undulated surface, chrome	
	70879V - LD6092	Rapier head CPL., RHS, with vulkollan, fine serrated, ceramic	
	70941K - LD2154/1	Rapier head CPL., LHS, with vulkollan, fine serrated, ceramic	
3-A	70125Ace – LD2155/1	<u>Original</u> Rapier head body, RHS, 8mm, ceramic (785128)	
3-B	70125Acr – LD2155/2	Rapier head body, RHS, 8mm, chrome	
4	334554 – LD2119	Centring washer	
5-A	785819 – LD2156/1	Clamp lever CPL., RHS, smooth surface	
5-B	70218H – LD2156/2	Clamp lever CPL., RHS, serrated surface (787398 fine)	
5-C	LD2156/3	Clamp lever CPL., RHS, undulated surface	
6	LD2122	Centring bush	
7	533023 – LD2010	Plastic plug	
8	333036 – LD2101	Bush	
9	333318 – LD2102	Socket head screw (M4x10)	
10	311208 – LD2014	Nut, M4	
11-A	785143 – LD2157/1	Rapier jaw CPL., RHS, with vulkollan, smooth surface	
11-B	71218G – LD2157/2	Rapier jaw CPL., RHS, with vulkollan, serrated surface	
	787366 – LD6015	Rapier jaw CPL., RHS, with vulkollan, fine serrated surface	
11-C	LD2157/3	Rapier jaw CPL., RHS, with vulkollan, lengthways grooved surface	
12-A	785142 – LD2158/1	Tungs. Carb. Ins., RHS, CPL, with vulkollan, smooth surface	

12-B	70218F – LD2158/2	Tungs. Carb. Ins., RHS, CPL, with vulkollan, serrated surface (787396 fine)	
12-C	LD2158/3	Tungs. Carb. Ins., RHS, CPL, with vulkollan, lengthways grooved surface	
13-A	337793 – LD2159/1	Tungs. Carb. Ins., RHS, smooth surface	
13-B	339479 – LD2159/2	Tungs. Carb. Ins., RHS, serrated surface (338237 fine)	
13-C	LD2159/3	Tungs. Carb. Ins., RHS, lengthways grooved surface,	
14	337795 – LD2160	Vulkollan, LHS (3,1 x 3,5 x 20mm)	
15	LD2161	Rapier jaw body, RHS	
16	410393 – LD2162	Rapier jaw CPL., massive undulated surface	
17	310943 – LD2163	Hexagon screw (M3x8)	
18	341914 – LD2023	Washer	
19	338925 – LD2164	Guide piece, RHS, black	
20	338286 – LD2165	Guide piece, RHS, grey	
21	335602 – LD2166	Guide piece, RHS, light grey	
22	328321 – LD2028	Locking element	
23	70226E – LD2167	Clamping spring CPL., RHS	
24	853226 – LD2168	Clamping stud, RHS	
25	339588 – LD2169	Socket head screw (M3x12)	
26	311206 – LD2022	Nut, M3	
27	309767 – LD2071	Setscrew (M4x4)	
28	711576 – LD2032	Upper guiding plate (0,5 x 6 x 14mm)	
29	410826 – LD2033	Lower guide plate (0,1 x 6 x 14mm)	
30	345444 – LD2141	Vulkollan guide	
31	322842 – LD2034	Spring (1,1 x 6 x 64mm)	
32	322843 – LD2035	Spring (1,1 x 6 x 50mm)	
33	322844 – LD2036	Spring (1,1 x 6 x 30mm)	
34	322532 – LD2045	Oval head screw (M4x8)	
35	410394 – LD2170	Washer	
39	335096 – LD2146	Fitting piece, "Y" form, 8mm	
40	70262S – LD2172	Side plate (21x3x9mm)	
41	335102 – LD2148	Oval head screw (M4x10)	
42	322502 – LD2046	Oval head screw (M4x25)	
43	322001 – LD2047	Nut, M4	
44	410301 – LD2048	Spring washer	
45	70045H – LD2149	Protecting sheet, 8mm	
46	338657 – LD2151	Stop piece, "U" form, 8mm	
47	339317 – LD2152	Guide piece	
48	311066 – LD2096	Hexagon screw (M4x10)	

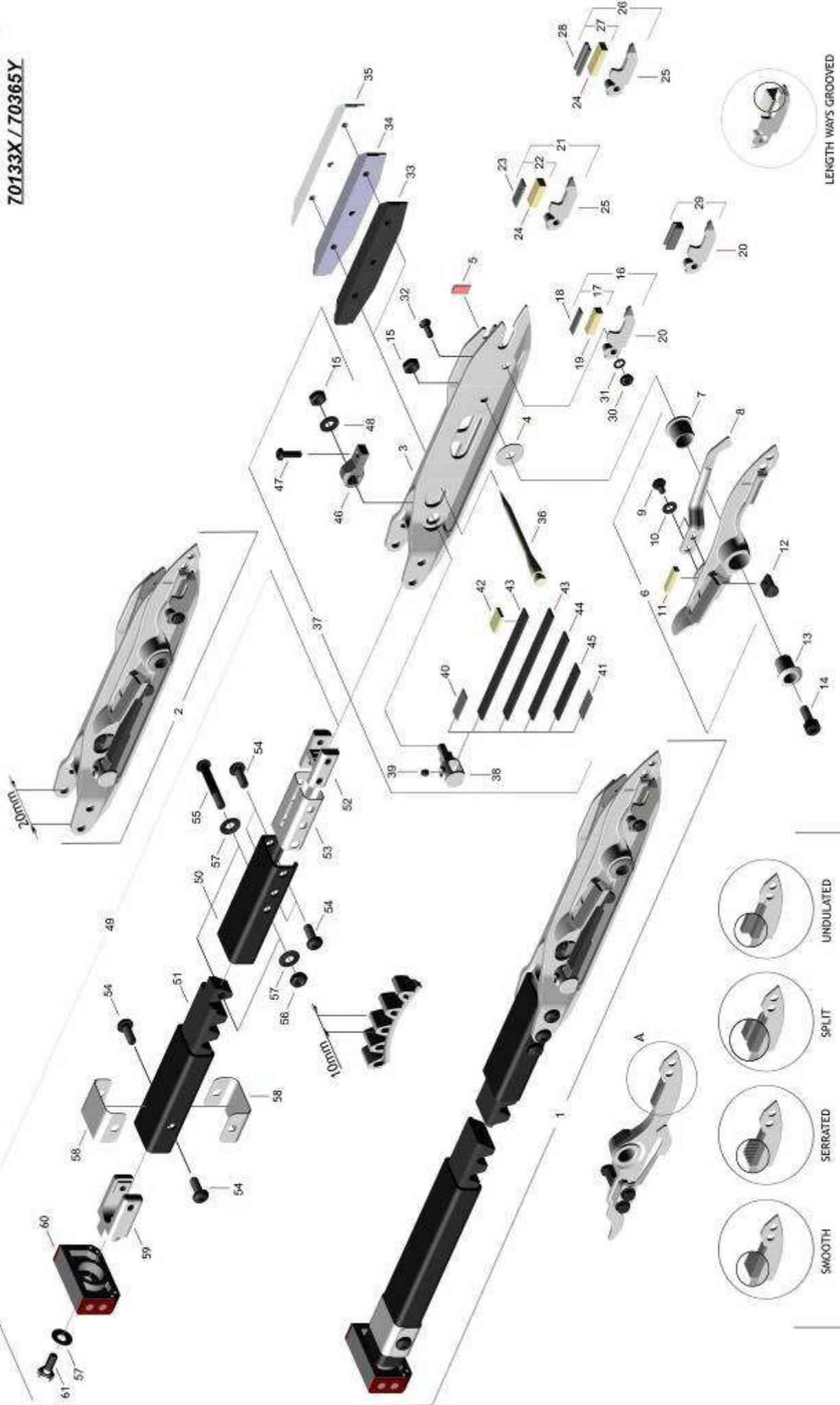

13	ORIGINAL – R.T.S CODES	DESCRIPTION	
1-A	70124Vce – LD2173/1	Rapier CPL., LHS, with vulkollan, smooth surface, ceramic	
1-B	70124Vcr – LD2173/2	Rapier CPL., LHS, with vulkollan, smooth surface, chrome	
1-C	70218T – LD2173/3	Rapier CPL., LHS, with vulkollan, serrated surface, ceramic (70128Ace fine)	
1-D	70218T – LD2173/4	Rapier CPL., LHS, with vulkollan, serrated surface, chrome (70128Acr fine)	
1-E	LD2173/5	Rapier CPL., LHS, with vulkollan, lengthways grooved surface, ceramic	
1-F	LD2173/6	Rapier CPL., LHS, with vulkollan, lengthways grooved surface, chrome	
1-G	LD2173/7	Rapier CPL., LHS, with vulkollan, smooth surface, 5mm, ceramic	
1-H	LD2173/8	Rapier CPL., LHS, with vulkollan, smooth surface, 5mm, chrome	
1-I	LD2173/9	Rapier CPL., LHS, with vulkollan, serrated surface, 5mm, ceramic	
1-J	LD2173/10	Rapier CPL., LHS, with vulkollan, serrated surface, 5mm, chrome	
1-K	LD2173/11	Rapier CPL., LHS, with vulkollan, lengthways grooved surface, 5mm, ceramic	
1-L	LD2173/12	Rapier CPL., LHS, with vulkollan, lengthways grooved surface, 5mm, chrome	
1-M	LD2173/13	Rapier CPL., LHS, with vulkollan, split smooth surface, 5mm, ceramic	
1-N	LD2173/14	Rapier CPL., LHS, with vulkollan, split smooth surface, 5mm, chrome	
1-O	LD2173/15	Rapier CPL., LHS, with vulkollan, split serrated surface, 5mm, ceramic	
1-P	LD2173/16	Rapier CPL., LHS, with vulkollan, split serrated surface, 5mm, chrome	
1-R	LD2173/17	Rapier CPL., LHS, with vulkollan, split lengthways grooved surface, 5mm, ceramic	
1-S	LD2173/18	Rapier CPL., LHS, with vulkollan, split lengthways grooved surface, 5mm, chrome	
1-T	LD2173/19	Rapier CPL., LHS, massive undulated surface, ceramic	
1-U	LD2173/20	Rapier CPL., LHS, massive undulated surface, chrome	
2-A	70133Xce – LD2117/1	<u>Original</u> Rapier head CPL., LHS, with vulkollan, smooth surface, ceramic	
2-B	70133Xcr – LD2117/2	Rapier head CPL., LHS, with vulkollan, smooth surface, chrome	
2-C	70218Sce – LD2117/3	<u>Original</u> Rapier head CPL., LHS, with vulkollan, serrated surface, ceramic (70427B fine)	
2-D	70218Scr – LD2117/4	Rapier head CPL., LHS, with vulkollan, serrated surface, chrome (70427B fine)	
2-E	70134Ace – LD2117/5	<u>Original</u> Rapier head CPL., LHS, with vulkollan, lengthways grooved surface, ceramic	
2-F	70134Acr – LD2117/6	Rapier head CPL., LHS, with vulkollan, lengthways grooved surface, chrome	
2-G	LD2117/7	<u>Original</u> Rapier head CPL., LHS, with vulkollan, smooth surface, 5mm, ceramic	
2-H	LD2117/8	Rapier head CPL., LHS, with vulkollan, smooth surface, 5mm, chrome	
2-I	LD2117/9	<u>Original</u> Rapier head CPL., LHS, with vulkollan, serrated surface, 5mm, ceramic	
2-J	LD2117/10	Rapier head CPL., LHS, with vulkollan, serrated surface, 5mm, chrome	
2-K	LD2117/11	<u>Original</u> Rapier head CPL., LHS, with vulkollan, lengthways grooved surface, 5mm, ceramic	
2-L	LD2117/12	Rapier head CPL., LHS, with vulkollan, lengthways grooved surface, 5mm, chrome	

2-M	LD2117/13	Rapier head CPL., LHS, with vulkollan, split smooth surface, 5mm, ceramic	
2-N	LD2117/14	Rapier head CPL., LHS, with vulkollan, split smooth surface, 5mm, chrome	
2-O	LD2117/15	Rapier head CPL., LHS, with vulkollan, split serrated surface, 5mm, ceramic	
2-P	LD2117/16	Rapier head CPL., LHS, with vulkollan, split serrated surface, 5mm, chrome	
2-R	LD2117/17	Rapier head CPL., LHS, with vulkollan, split lengthways grooved surface, 5mm, ceramic	
2-S	LD2117/18	Rapier head CPL., LHS, with vulkollan, split lengthways grooved surface, 5mm, chrome	
2-T	LD2117/19	Rapier head CPL., LHS, massive undulated surface, ceramic	
2-U	LD2117/20	Rapier head CPL., LHS, massive undulated surface, chrome	
3-A	70365Yce – LD2118/1	Rapier head body, LHS, 8mm, ceramic	
3-B	70365Ycr – LD2118/2	Rapier head body, LHS, 8mm, chrome	
4	334554 – LD2119	Centring washer	
5	450171 – LD2120	Ceramic piece	
6-A	70388D – LD2121/1	Clamp lever CPL., LHS, smooth surface	
6-B	70218R – LD2121/2	Clamp lever CPL., LHS, serrated surface (<i>70412R fine</i>)	
6-C	LD2121/3	Clamp lever CPL., LHS, smooth surface, 5mm	
6-D	LD2121/4	Clamp lever CPL., LHS, serrated surface, 5mm	
6-E	LD2121/5	Clamp lever CPL., LHS, split, smooth surface, 5mm	
6-F	LD2121/6	Clamp lever CPL., LHS, split, serrated surface, 5mm	
6-G	LD2121/7	Clamp lever CPL., LHS, undulated surface	
7	LD2122	Centring bush	
8	767894 – LD2007	Line feed lever	
9	311179 – LD2008	Hexhagon screw (M3x4)	
10	301701 – LD2009	Washer	
11	342799 – LD2123	Vulkollan guide	
12	533023 – LD2010	Plastic plug	
13	333036 – LD2101	Bush	
14	333318 – LD2102	Socket head screw (M4x10)	
15	311208 – LD2014	Nut, M4	
16-A	785172 – LD2124/1	Rapier jaw CPL., LHS, with vulkollan, smooth surface	
16-B	70218P – LD2124/2	Rapier jaw CPL., LHS, with vulkollan, serrated surface	
16-C	LD2124/3	Rapier jaw CPL., LHS, with vulkollan, lengthways grooved surface	
17-A	765150 – LD2125/1	Tungs. Carb. Ins., LHS, CPL, with vulkollan, smooth surface	
17-B	765276 – LD2125/2	Tungs. Carb. Ins., LHS, CPL, with vulkollan, serrated surface (<i>765271 fine</i>)	
17-C	LD2125/3	Tungs. Carb. Ins., LHS, CPL, with vulkollan, lengthways grooved surface	
18-A	471160 – LD2017/1	Tungs. Carb. Ins., LHS, smooth surface	
18-B	471196 – LD2017/2	Tungs. Carb. Ins., LHS, serrated surface	

18-C	471411 – LD6027	Tungs. Carb. Ins., LHS, fine serrated surface	
18-C	LD2017/3	Tungs. Carb. Ins., LHS, lengthways grooved surface	
19	334421 – LD2126	Vulkollan, LHS, 5mm (3,8 x 3,8 x 12,5mm)	
20	LD2127	Rapier jaw body, LHS	
21-A	71199G – LD2128/1	Rapier jaw CPL., LHS, with vulkollan, smooth surface, 5mm	
21-B	71199K – LD2128/2	Rapier jaw CPL., LHS, with vulkollan, serrated surface, 5mm	
21-C	72544R – LD2128/3	Rapier jaw CPL., LHS, with vulkollan, lengthways grooved surface, 5mm	
22-A	70688C – LD2129/1	Tungs. Carb. Ins., LHS, CPL, with vulkollan, smooth surface, 5mm	
22-B	70687Y – LD2129/2	Tungs. Carb. Ins., LHS, CPL, with vulkollan, serrated surface, 5mm	
22-C	72544P – LD2129/3	Tungs. Carb. Ins., LHS, CPL, with vulkollan, lengthways grooved surface, 5mm	
23-A	342823 – LD2130/1	Tungs. Carb. Ins., LHS, CPL, smooth surface, 5mm	
23-B	342825 – LD2130/2	Tungs. Carb. Ins., LHS, CPL, serrated surface, 5mm	
23-C	348714 – LD2130/3	Tungs. Carb. Ins., LHS, CPL, lengthways surface, 5mm	
24	342827 – LD2131	Vulkollan, LHS (3,5 x 5 x 15,5mm)	
25	LD2132	Rapier jaw body, LHS, 5mm	
26-A	LD2133/1	Rapier jaw CPL., LHS, with vulkollan, split smooth surface, 5mm	
26-B	LD2133/2	Rapier jaw CPL., LHS, with vulkollan, split serrated surface, 5mm	
26-C	LD2133/3	Rapier jaw CPL., LHS, with vulkollan, split lengthways grooved surface, 5mm	
27-A	LD2134/1	Tungs. Carb. Ins., LHS, CPL, with vulkollan, split smooth surface, 5mm	
27-B	LD2134/2	Tungs. Carb. Ins., LHS, CPL, with vulkollan, split serrated surface, 5mm	
27-C	LD2134/3	Tungs. Carb. Ins., LHS, CPL, with vulkollan, split lengthways grooved surface, 5mm	
28-A	LD2135/1	Tungs. Carb. Ins., LHS, CPL, with vulkollan, split smooth surface, 5mm	
28-B	LD2135/2	Tungs. Carb. Ins., LHS, CPL, with vulkollan, split serrated surface, 5mm	
28-C	LD2135/3	Tungs. Carb. Ins., LHS, CPL, with vulkollan, split lengthways grooved surface, 5mm	
29	LD2136	Rapier jaw CPL., LHS, massive undulated surface	
30	311206 – LD2022	Nut, M3	
31	341914 – LD2023	Washer	
32	337910 – LD2024	Countersunk screw (M3 x 6)	
33	338924 – LD2137	Guide piece, LHS, black	
34	338287 – LD2138	Guide piece, LHS, grey	
35	335603 – LD2139	Guide piece, LHS, light grey	
36	328321 – LD2028	Locking element	
37	70225E – LD2140	Clamping spring CPL., LHS	
38	707873 – LD2030	Clamping stud, LHS	
39	309758 – LD2031	Setscrew (M3x4)	
40	711576 – LD2032	Upper guide plate	

41	410826 – LD2033	Lower guide plate (0,1 x 6 x 14mm)	
42	345444 – LD2141	Vulkollan guide (345444)	
43	322842 – LD2034	Spring (1,1 x 6 x 64mm) (72026V with vulkollan)	
44	322843 – LD2035	Spring (1,1 x 6 x 50mm)	
45	322844 – LD2036	Spring (1,1 x 6 x 30mm)	
46	769850 – LD2037	Stop piece, LHS	
47	339588 – LD2142	Oval head screw (M3x10)	
48	301702 – LD2039	Washer	
52	768452 – LD2175	Fitting piece, "H" form, 8mm	
53	853316 – LD2043	Adaptor	
54	322532 – LD2045	Oval head screw (M4x8)	
55	322502 – LD2046	Oval head screw (M4x25)	
56	322001 – LD2047	Nut, M4	
57	410301 – LD2048	Spring washer	
58	853329 – LD2049	Protecting sheet, 10mm	
59	334982 – LD2094	Stop piece, "U" form, 10mm	
60	339317 – LD2095	Guide piece	
61	311066 – LD2096	Hexagon screw (M4x10)	

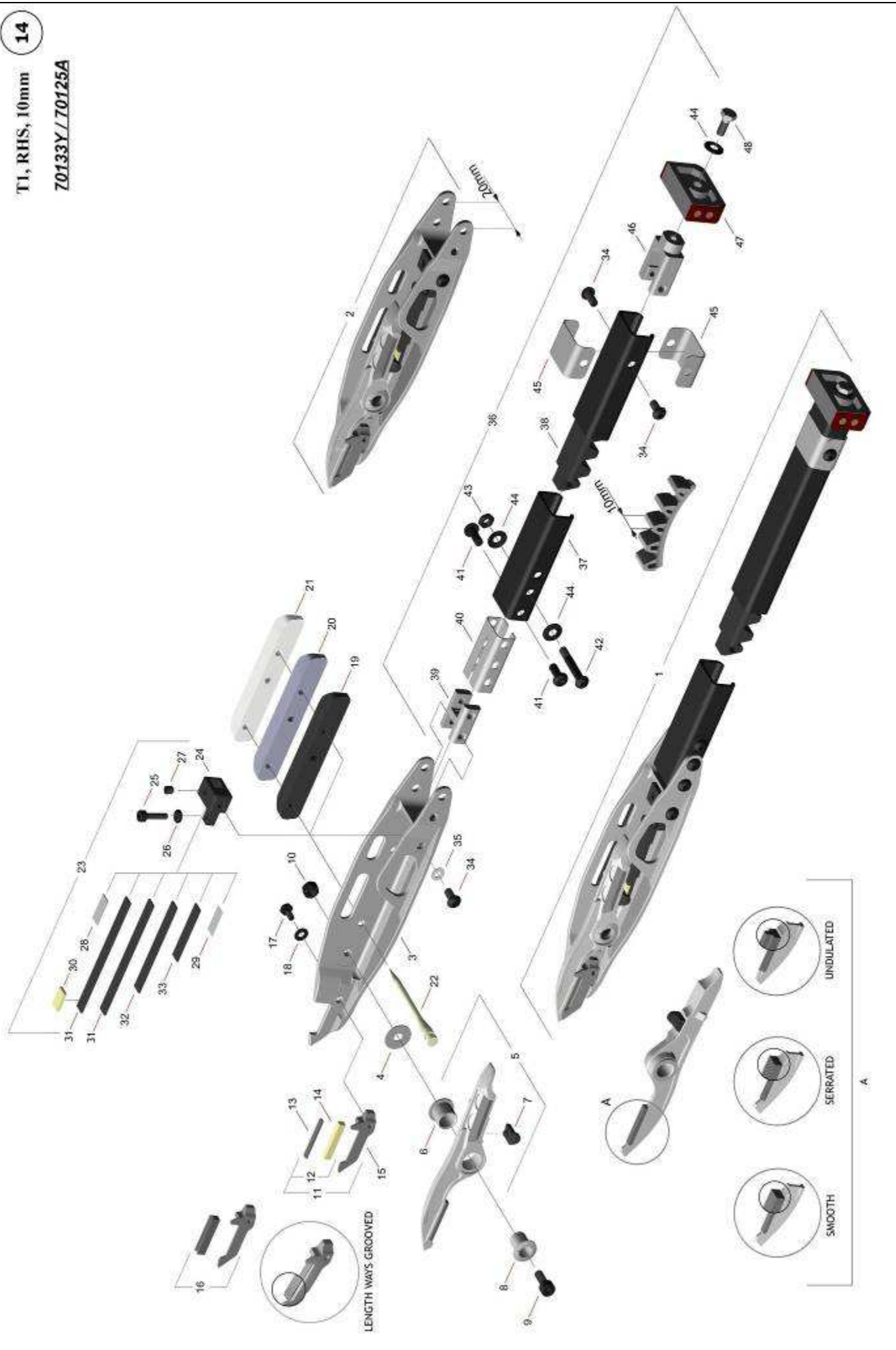

14	ORIGINAL – R.T.S CODES	DESCRIPTION	
1-A	70124Yce – LD2176/1	Rapier CPL., RHS, with vulkollan, smooth surface, ceramic	
1-B	70124Ycr – LD2176/2	Rapier CPL., RHS, with vulkollan, smooth surface, chrome	
1-C	70218Lce – LD2176/3	Rapier CPL., RHS, with vulkollan, serrated surface, ceramic (70128Bce fine)	
1-D	70218Lcr – LD2176/4	Rapier CPL., RHS, with vulkollan, serrated surface, chrome (70128Bcr fine)	
1-E	LD2176/5	Rapier CPL., RHS, with vulkollan, lengthways grooved surface, ceramic	
1-F	LD2176/6	Rapier CPL., RHS, with vulkollan, lengthways grooved surface, chrome	
1-G	LD2176/7	Rapier CPL., RHS, massive undulated surface, ceramic	
1-H	LD2176/8	Rapier CPL., RHS, massive undulated surface, chrome	
2-A	70133Yce – LD2154/1	<u>Original</u> Rapier head CPL., RHS, with vulkollan, smooth surface, ceramic	
2-B	70133Ycr – LD2154/2	Rapier head CPL., RHS, with vulkollan, smooth surface, chrome	
2-C	70218Kce – LD2154/3	<u>Original</u> Rapier head CPL., RHS, with vulkollan, serrated surface, ceramic (70133Wce fine)	
2-D	70218Kcr – LD2154/4	Rapier head CPL., RHS, with vulkollan, serrated surface, chrome (70133Wcr fine)	
2-E	LD2154/5	<u>Original</u> Rapier head CPL., RHS, with vulkollan, lengthways grooved surface, ceramic	
2-F	LD2154/6	Rapier head CPL., RHS, with vulkollan, lengthways grooved surface, chrome	
2-G	LD2154/7	<u>Original</u> Rapier head CPL., RHS, massive undulated surface, ceramic	
2-H	LD2154/8	Rapier head CPL., RHS, massive undulated surface, chrome	
3-A	70125Ace – LD2155/1	<u>Original</u> Rapier head body, RHS, 8mm, ceramic (785128)	
3-B	70125Acr – LD2155/2	Rapier head body, RHS, 8mm, chrome	
4	334554 – LD2119	Centring washer	
5-A	785819 – LD2156/1	Clamp lever CPL., RHS, smooth surface	
5-B	70218H – LD2156/2	Clamp lever CPL., RHS, serrated surface (787398 fine)	
5-C	LD2156/3	Clamp lever CPL., RHS, undulated surface	
6	LD2122	Centring bush	
7	533023 – LD2010	Plastic plug	
8	333036 – LD2101	Bush	
9	333318 – LD2102	Socket head screw (M4x10)	
10	311208 – LD2014	Nut, M4	
11-A	785143 – LD2157/1	Rapier jaw CPL., RHS, with vulkollan, smooth surface	
11-B	71218G – LD2157/2	Rapier jaw CPL., RHS, with vulkollan, serrated surface	
	787366 – LD6015	Rapier jaw CPL., RHS, with vulkollan, fine serrated surface	
11-C	LD2157/3	Rapier jaw CPL., RHS, with vulkollan, lengthways grooved surface	
12-A	785142 – LD2158/1	Tungs. Carb. Ins., RHS, CPL, with vulkollan, smooth surface	
12-B	70218F – LD2158/2	Tungs. Carb. Ins., RHS, CPL, with vulkollan, serrated surface (787396 fine)	
12-C	LD2158/3	Tungs. Carb. Ins., RHS, CPL, with vulkollan, lengthways grooved surface	

13-A	337793 – LD2159/1	Tungs. Carb. Ins., RHS, smooth surface	
13-B	339479 – LD2159/2	Tungs. Carb. Ins., RHS, serrated surface (338237 fine)	
13-C	LD2159/3	Tungs. Carb. Ins., RHS, lengthways grooved surface,	
14	337795 – LD2160	Vulkollan, LHS (3,1 x 3,5 x 20mm)	
15	LD2161	Rapier jaw body, RHS	
16	410393 – LD2162	Rapier jaw CPL., massive undulated surface	
17	310943 – LD2163	Hexagon screw (M3x8)	
18	341914 – LD2023	Washer	
19	338925 – LD2164	Guide piece, RHS, black	
20	338286 – LD2165	Guide piece, RHS, grey	
21	335602 – LD2166	Guide piece, RHS, light grey	
22	328321 – LD2028	Locking element	
23	70226E – LD2167	Clamping spring CPL., RHS	
24	853226 – LD2168	Clamping stud, RHS	
25	339588 – LD2169	Socket head screw (M3x12)	
26	311206 – LD2022	Nut, M3	
27	309767 – LD2071	Setscrew (M4x4)	
28	711576 – LD2032	Upper guiding plate (0,5 x 6 x 14mm)	
29	410826 – LD2033	Lower guide plate (0,1 x 6 x 14mm)	
30	345444 – LD2141	Vulkollan guide	
31	322842 – LD2034	Spring (1,1 x 6 x 64mm)	
32	322843 – LD2035	Spring (1,1 x 6 x 50mm)	
33	322844 – LD2036	Spring (1,1 x 6 x 30mm)	
34	322532 – LD2045	Oval head screw (M4x8)	
35	410394 – LD2170	Washer	
39	768452 – LD2175	Fitting piece, "H" form, 10mm	
40	853316 – LD2043	Adaptor	
41	335102 – LD2148	Oval head screw (M4x10)	
42	322502 – LD2046	Oval head screw (M4x25)	
43	322001 – LD2047	Nut, M4	
44	410301 – LD2048	Spring washer	
45	853329 – LD2049	Protecting sheet, 10mm	
46	334982 – LD2094	Stop piece, 10mm, "U" form	
47	339317 – LD2095	Guide piece	
48	311066 – LD2096	Hexagon screw (M4x10)	

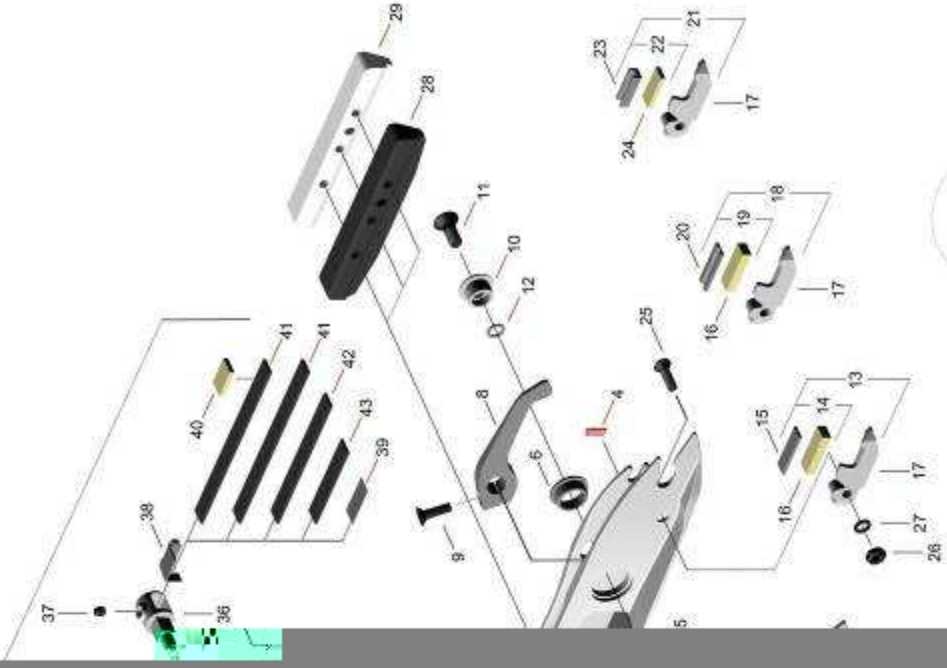

LENGTHWAYS GROOVED

15	ORIGINAL – R.T.S CODES	DESCRIPTION	
1-A	71164Kce – LD2177/1	Rapier CPL., LHS, with vulkollan, smooth surface, ceramic	
1-B	71161Kcr – LD2177/2	Rapier CPL., LHS, with vulkollan, smooth surface, chrome	
1-C	71164Lce – LD2177/3	Rapier CPL., LHS, with vulkollan, serrated surface, ceramic	
1-D	71164Lcr – LD2177/4	Rapier CPL., LHS, with vulkollan, serrated surface, chrome	
1-E	71164L – LD2177/5	Rapier CPL., LHS, with vulkollan, lengthways grooved surface, ceramic	
1-F	LD2177/6	Rapier CPL., LHS, with vulkollan, lengthways grooved surface, chrome	
1-G	LD2177/7	Rapier CPL., LHS, with vulkollan, split, smooth surface, ceramic	
1-H	LD2177/8	Rapier CPL., LHS, with vulkollan, split, smooth surface, chrome	
1-I	LD2177/9	Rapier CPL., LHS, with vulkollan, split, serrated surface, ceramic	
1-J	LD2177/10	Rapier CPL., LHS, with vulkollan, split, serrated surface, chrome	
1-K	LD2177/11	Rapier CPL., LHS, with vulkollan, split, lengthways grooved surface, ceramic	
1-L	LD2177/12	Rapier CPL., LHS, with vulkollan, split, lengthways grooved surface, chrome	
1-M	LD2177/13	Rapier CPL., LHS, with vulkollan, undulated surface, ceramic	
1-N	LD2177/14	Rapier CPL., LHS, with vulkollan, undulated surface, chrome	
2-A	71161Rce – LD2178 /1	<u>Original</u> Rapier head CPL., LHS, with vulkollan, smooth surface, ceramic	
2-B	71616Rcr – LD2178/2	Rapier head CPL., LHS, with vulkollan, smooth surface, chrome	
2-C	71161Xce – LD2178/3	<u>Original</u> Rapier head CPL., LHS, with vulkollan, serrated surface, ceramic	
2-D	71161Xcr – LD2178/4	Rapier head CPL., LHS, with vulkollan, serrated surface, chrome(71210T-71723B)	
2-E	71161X – LD2178/5	<u>Original</u> Rapier head CPL., LHS, with vulkollan, lengthways grooved surface, ceramic	
2-F	LD2178/6	Rapier head CPL., LHS, with vulkollan, lengthways grooved surface, chrome	
2-G	LD2178/7	<u>Original</u> Rapier head CPL., LHS, with vulkollan, split, smooth surface, ceramic	
2-H	LD2178/8	Rapier head CPL., LHS, with vulkollan, split, smooth surface, chrome	
2-I	LD2178/9	<u>Original</u> Rapier head CPL., LHS, with vulkollan, split, serrated surface, ceramic	
2-J	LD2178/10	Rapier head CPL., LHS, with vulkollan, split, serrated surface, chrome	
2-K	LD2178/11	<u>Original</u> Rapier head CPL., LHS, with vulkollan, split, lengthways grooved surface, ceramic	
2-L	LD2178/12	Rapier head CPL., LHS, with vulkollan, split, lengthways grooved surface, chrome	
2-M	LD2178/13	<u>Original</u> Rapier head CPL., LHS, with vulkollan, undulated surface, ceramic	
2-N	LD2178/14	Rapier head CPL., LHS, with vulkollan, undulated surface, chrome	
3-A	71861Kce – LD2179/1	<u>Original</u> Rapier head body, LHS, 8mm, ceramic	
3-B	71861Kcr – LD2179/2	Rapier head body, LHS, 8mm, chrome (=71210G)	
4	450124 – LD2180	Ceramic piece	
5	LD2181	Bush, 10mm	

6	LD2182	Bush, 8mm	
7-A	71246V – LD2183/1	Clamp lever CPL., LHS, smooth surface (70861G)	
7-B	71297P – LD2183/2	Clamp lever CPL., LHS, serrated surface	
7-C	LD2183/3	Clamp lever CPL., LHS, split, smooth surface	
7-D	LD2183/4	Clamp lever CPL., LHS, split, serrated surface	
7-E	71340N – LD2183/5	Clamp lever CPL., LHS, undulated surface	
8	70861E – LD2184	Line feed lever	
9	345098 – LD2185	Countersunk screw (M3x8)	
10	341167 – LD2186	Special bush	
11	345105 – LD2187	Countersunk screw (M4x8)	
12-A	70299X – LD2188/1	Adjustment washer (4,0 x 6,0 x 0,1mm)	
12-B	70299Y – LD2188/2	Adjustment washer (4,0 x 6,0 x 0,3mm)	
12-C	70300A – LD2188/3	Adjustment washer (4,0 x 6,0 x 0,5mm)	
13-A	71199G – LD2128/1	Rapier jaw CPL., LHS, with vulkollan, smooth surface, 5mm	
13-B	71199K – LD2128/2	Rapier jaw CPL., LHS, with vulkollan, serrated surface, 5mm	
	71199H - LDLD6073	Rapier jaw CPL., LHS, with vulkollan, fine serrated surface, 5mm	
13-C	72544R – LD2128/3	Rapier jaw CPL., LHS, with vulkollan, lengthways grooved surface, 5mm	
14-A	70688C – LD2129/1	Tungs. Carb. Ins., LHS, CPL, with vulkollan, smooth surface, 5mm	
14-B	70687Y – LD2129/2	Tungs. Carb. Ins., LHS, CPL, with vulkollan, serrated surface, 5mm (70687V fine)	
14-B	70687V / LD6055	Tungs. Carb. Ins., LHS, CPL, with vulkollan, fine serrated surface, 5mm)	
14-C	72544P - LD2129/3	Tungs. Carb. Ins., LHS, CPL, with vulkollan, lengthways grooved surface, 5mm	
15-A	342823 – LD2130/1	Tungs. Carb. Ins., LHS, smooth surface, 5mm	
15-B	342825 – LD2130/2	Tungs. Carb. Ins., LHS, serrated surface, 5mm (342826 fine)	
15-C	348714 - LD2130/3	Tungs. Carb. Ins., LHS, lengthways grooved surface, 5mm	
16	342827 - LD2131	Vulkollan, LHS (3,5 x 5 x 15,5mm)	
17	LD2132	Rapier jaw body, LHS, 5mm	
18-A	LD2133/1	Rapier jaw CPL., LHS, with vulkollan, split smooth surface, 5mm	
18-B	LD2133/2	Rapier jaw CPL., LHS, with vulkollan, split serrated surface, 5mm	
18-C	LD2133/3	Rapier jaw CPL., LHS, with vulkollan, split lengthways grooved surface, 5mm	
19-A	LD2134/1	Tungs. Carb. Ins., LHS, CPL, with vulkollan, split smooth surface, 5mm	
19-B	LD2134/2	Tungs. Carb. Ins., LHS, CPL, with vulkollan, split serrated surface, 5mm	
19-C	LD2134/3	Tungs. Carb. Ins., LHS, CPL, with vulkollan, split lengthways grooved surface, 5mm	
20-A	LD2135/1	Tungs. Carb. Ins., LHS, CPL, with vulkollan, split smooth surface, 5mm	
20-B	LD2135/2	Tungs. Carb. Ins., LHS, CPL, with vulkollan, split serrated surface, 5mm	
20-C	LD2135/3	Tungs. Carb. Ins., LHS, CPL, with vulkollan, split lengthways grooved surface, 5mm	
21	71239X - LD2189	Rapier jaw CPL., LHS, with vulkollan, undulated surface, 5mm	
22	71239W - LD2190	Tungs. Carb. Ins. CPL., LHS, with vulkollan, undulated, 5mm	

23	345379 - LD2191	Tungs. Carb. Ins., LHS, undulated, 5mm	
24	345374 - LD2192	Vulkollan, LHS (5 x 2 x 16mm)	
25	341050 - LD2193	Countersunk screw (M3 x 8) (345098)	
26	311206 - LD2022	Nut, M3	
27	341914 - LD2023	Washer	
28	345187 - LD2194	Guide piece, LHS, black (343743, 345186)	
29	345188 - LD2195	Guide piece, LHS, light grey	
30	328321 - LD2028	Locking element	
31	70861H - LD2196	Clamping spring CPL., LHS	
32	769850 - LD2037	Stop piece, LHS	
33	338999 - LD2142	Oval head screw (M3x10)	
34	311208 - LD2014	Nut, M4	
35	301702 - LD2039	Washer	
36	707873 - LD2093	Clamping stud, LHS	
37	309758 - LD2031	Setscrew (M3x4)	
38	711576 - LD2234	Upper guide plate	
39	410826 - LD2033	Lower guide plate (0,1 x 6 x 14mm)	
40	345444 - LD2141	Vulkollan guide	
41	322842 - LD2034	Spring (1,1 x 6 x 64mm)	
42	322843 - LD2035	Spring (1,1 x 6 x 50mm)	
43	322844 - LD2036	Spring (1,1 x 6 x 30mm)	
47	LD2198	Fitting piece, "I" form	
48	335102 - LD2148	Oval head screw (M4x10)	
49	322532 - LD2045	Oval head screw (M4x8)	
50	410301 - LD2048	Spring washer	
51	70045H - LD2149	Protecting sheet, 8mm	
52	338657 - LD2151	Stop piece, "U" form, 8mm	
53	339317 - LD2152	Guide piece	
54	311066 - LD2096	Hexagon screw (M4x10)	



16	ORIGINAL – R.T.S CODES	DESCRIPTION	
1-A	71164Hce - LD2199/1	Rapier CPL., RHS, with vulkollan, smooth surface, ceramic	
1-B	71161Hcr - LD2199/2	Rapier CPL., RHS, with vulkollan, smooth surface, chrome	
1-C	71164Mce - LD2199/3	Rapier CPL., RHS, with vulkollan, serrated surface, ceramic (71205Y)	
1-D	71164Mcr - LD2199/4	Rapier CPL., RHS, with vulkollan, serrated surface, chrome	
1-E	71164M - LD2199/5	Rapier CPL., RHS, with vulkollan, lengthways grooved surface, ceramic	
1-F	LD2199/6	Rapier CPL., RHS, with vulkollan, lengthways grooved surface, chrome	
1-G	LD2199/7	Rapier CPL., RHS, with vulkollan, undulated surface, ceramic	
1-H	LD2199/8	Rapier CPL., RHS, with vulkollan, undulated surface, chrome	
2-A	71161Wce - LD2200 /1	Rapier head CPL., RHS, with vulkollan, smooth surface, ceramic	
2-B	71161Wcr - LD2200/2	Rapier head CPL., RHS, with vulkollan, smooth surface, chrome	
2-C	71162Bce - LD2200/3	Rapier head CPL., RHS, with vulkollan, serrated surface, ceramic	
2-D	71162Bcr - LD2200/4	Rapier head CPL., RHS, with vulkollan, serrated surface, chrome (71203P)	
2-E	71162B - LD2200/5	Rapier head CPL., RHS, with vulkollan, lengthways grooved surface, ceramic	
2-F	LD2200/6	Rapier head CPL., RHS, with vulkollan, lengthways grooved surface, chrome	
2-G	LD2200/7	Rapier head CPL., RHS, with vulkollan, undulated surface, ceramic	
2-H	LD2200/8	Rapier head CPL., RHS, with vulkollan, undulated surface, chrome	
3-A	71860Cce – LD2201/1	Rapier head body, RHS, 8mm, ceramic	
3-B	71860Ccr – LD2201/2	Rapier head body, RHS, 8mm, chrome	
4	334554 – LD2119	Centring washer	
5-A	70860H – LD2202/1	Clamp lever CPL., RHS, smooth surface	
5-B	71297W - LD2202/2	Clamp lever CPL., RHS, serrated surface	
5-C	71340W - LD2202/3	Clamp lever CPL., RHS, undulated surface	
6	LD2122	Centring bush	
7	333036 - LD2101	Bush	
8	333318 - LD2102	Socket head screw (M4x10)	
9	311208 - LD2014	Nut, M4	
10-A	70985L – LD2203/1	Rapier jaw CPL., RHS, with vulkollan, smooth surface	
10-B	70745G – LD2203/2	Rapier jaw CPL., RHS, with vulkollan, serrated surface	
10-C	75545P – LD2203/3	Rapier jaw CPL., RHS, with vulkollan, lengthways grooved surface	
11-A	785142 – LD2204/1	Tungs. Carb. Ins., RHS, CPL, with vulkollan, smooth surface	
11-B	787396 – LD2204/2	Tungs. Carb. Ins., RHS, CPL, with vulkollan, serrated surface	
11B	70941G / LD6054	Tungs. Carb. Ins., RHS, CPL, with vulkollan, fine serrated surface	
11-C	72545N – LD2204/3	Tungs. Carb. Ins., RHS, CPL, with vulkollan, lengthways grooved surface (70941G)	
12-A	337793 – LD2205/1	Tungs. Carb. Ins., RHS, smooth surface (343904)	

12-B	338237 – LD2205/2	Tungs. Carb. Ins., RHS, serrated surface (344104)	
12-C	348715 - LD2205/3	Tungs. Carb. Ins., RHS, lengthways grooved surface,	
13	337795 – LD2206	Vulkollan, LHS (3,5 x 3,5 x 20mm)	
14	LD2207	Rapier jaw body, RHS	
15	71240D – LD2208	Rapier jaw CPL., RHS, with vulkollan, undulated surface	
16	71240F - LD2209	Tungs. Carb. Ins. CPL., RHS, with vulkollan, undulated	
17	345382 - LD2210	Tungs. Carb. Ins., RHS, undulated	
18	345381 - LD2211	Vulkollan, LHS (2 x 3,5 x 22mm)	
19	310943 – LD2163	Hexagon screw (M3x8)	
20	341914 – LD2023	Washer	
21	343743 - LD2194	Guide piece, RHS, black (343743, 345187, 345186)	
22	345188 – LD2195	Guide piece, RHS, light grey	
23	328321 – LD2028	Locking element	
24	70860K – LD2212	Clamping spring CPL., RHS	
25	70744E – LD2213	Clamping stud, RHS	
26	311884 – LD2235	Hexagon screw (M3x10)	
27	309767 – LD2071	Setscrew (M4x4)	
28	711576 – LD2032	Upper guiding plate (0,5 x 6 x 14mm)	
29	410826 – LD2033	Lower guide plate (0,1 x 6 x 14mm)	
30	345444 – LD2141	Vulkollan guide	
31	322842 – LD2034	Spring (1,1 x 6 x 64mm)	
32	322843 – LD2035	Spring (1,1 x 6 x 50mm)	
33	322844 – LD2036	Spring (1,1 x 6 x 30mm)	
34	322532 - LD2045	Oval head screw (M4x8)	
35	410394 - LD2170	Washer	
39	LD2198	Fitting piece, "I" form	
40	335102 – LD2148	Oval head screw (M4x10)	
41	410301 - LD2048	Spring washer	
42	70045H – LD2149	Protecting sheet, 8mm	
43	338657 - LD2151	Stop piece, "U" form, 8mm	
44	339317 – LD2152	Guide piece	
45	311066 – LD2096	Hexagon screw (M4x10)	

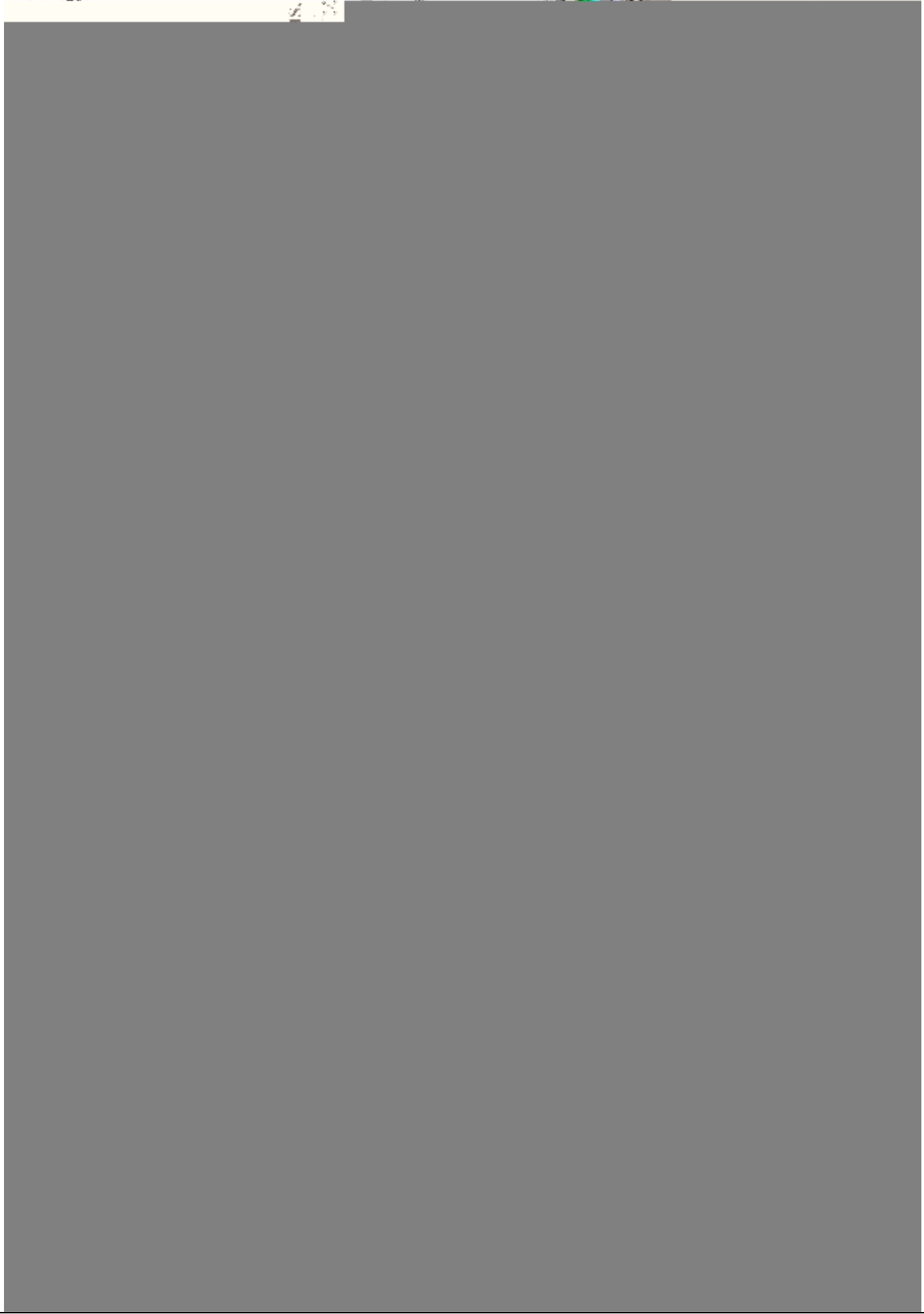
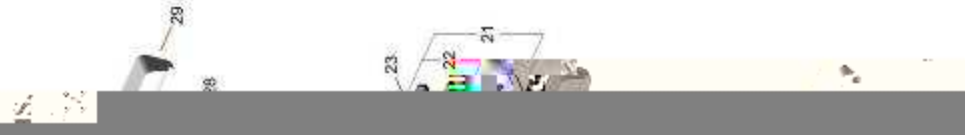

17	ORIGINAL – R.T.S CODES	DESCRIPTION	
1-A	71712Ece – LD2214/1	Rapier CPL., LHS, with vulkollan, smooth surface, ceramic	
1-B	71712Ecr – LD2214/2	Rapier CPL., LHS, with vulkollan, smooth surface, chrome	
1-C	71781Kce – LD2214/3	Rapier CPL., LHS, with vulkollan, serrated surface, ceramic	
1-D	71781Kcr – LD2214/4	Rapier CPL., LHS, with vulkollan, serrated surface, chrome	
1-E	72544M - LD2214/5	Rapier CPL., LHS, with vulkollan, lengthways grooved surface, ceramic	
1-F	LD2214/6	Rapier CPL., LHS, with vulkollan, lengthways grooved surface, chrome	
1-G	LD2214/7	Rapier CPL., LHS, with vulkollan, split, smooth surface, ceramic	
1-H	LD2214/8	Rapier CPL., LHS, with vulkollan, split, smooth surface, chrome	
1-I	LD2214/9	Rapier CPL., LHS, with vulkollan, split, serrated surface, ceramic	
1-J	LD2214/10	Rapier CPL., LHS, with vulkollan, split, serrated surface, chrome	
1-K	LD2214/11	Rapier CPL., LHS, with vulkollan, split, lengthways grooved surface, ceramic	
1-L	LD2214/12	Rapier CPL., LHS, with vulkollan, split, lengthways grooved surface, chrome	
1-M	71782Dce - LD2214/13	Rapier CPL., LHS, with vulkollan, undulated surface, ceramic	
1-N	71782Dcr - LD2214/14	Rapier CPL., LHS, with vulkollan, undulated surface, chrome	
2-A	71328Hce – LD2215/1	Rapier head CPL., LHS, with vulkollan, smooth surface, ceramic	
2-B	71328Hcr – LD2215/2	Rapier head CPL., LHS, with vulkollan, smooth surface, chrome	
2-C	71781Lce – LD2215/3	Rapier head CPL., LHS, with vulkollan, serrated surface, ceramic	
2-D	71781Lcr – LD2215/4	Rapier head CPL., LHS, with vulkollan, serrated surface, chrome	
2-E	72544N - LD2215/5	Rapier head CPL., LHS, with vulkollan, lengthways grooved surface, ceramic	
2-F	LD2215/6	Rapier head CPL., LHS, with vulkollan, lengthways grooved surface, chrome	
2-G	LD2215/7	Rapier head CPL., LHS, with vulkollan, split, smooth surface, ceramic	
2-H	LD2215/8	Rapier head CPL., LHS, with vulkollan, split, smooth surface, chrome	
2-I	LD2215/9	Rapier head CPL., LHS, with vulkollan, split, serrated surface, ceramic	
2-J	LD2215/10	Rapier head CPL., LHS, with vulkollan, split, serrated surface, chrome	
2-K	LD2215/11	Rapier head CPL., LHS, with vulkollan, split, lengthways grooved surface, ceramic	
2-L	LD2215/12	Rapier head CPL., LHS, with vulkollan, split, lengthways grooved surface, chrome	
2-M	71624Gce - LD2215/13	Rapier head CPL., LHS, with vulkollan, undulated surface, ceramic	
2-N	71624Gcr - LD2215/14	Rapier head CPL., LHS, with vulkollan, undulated surface, chrome	
3-A	71328Lce – LD2216/1	Rapier head body, LHS, 9mm, ceramic	
3-B	71328Lcr – LD2216/2	Rapier head body, LHS, 9mm, chrome	
4	450124 – LD2180	Ceramic piece	
5	LD2181	Bush, 10mm	
6	LD2182	Bush, 8mm	
7-A	71246V – LD2183/1	Clamp lever CPL., LHS, smooth surface	

7-B	71297P – LD2183/2	Clamp lever CPL., LHS, serrated surface	
7-C	LD2183/3	Clamp lever CPL., LHS, split, smooth surface	
7-D	LD2183/4	Clamp lever CPL., LHS, split, serrated surface	
7-E	71340N – LD2183/5	Clamp lever CPL., LHS, undulated surface	
8	70861E – LD2184	Line feed lever	
9	345098 – LD2185	Countersunk screw (M3x8)	
10	341167 – LD2186	Special bush	
11	345105 – LD2187	Countersunk screw (M4x8)	
12-A	70299X – LD2188/1	Adjustment washer (4,0 x 6,0 x 0,1mm)	
12-B	70299Y – LD2188/2	Adjustment washer (4,0 x 6,0 x 0,3mm)	
12-C	70300A – LD2188/3	Adjustment washer (4,0 x 6,0 x 0,5mm)	
13-A	71199G – LD2128/1	Rapier jaw CPL., LHS, with vulkollan, smooth surface, 5mm	
13-B	71199K – LD2128/2	Rapier jaw CPL., LHS, with vulkollan, serrated surface, 5mm	
	71199H - LDLD6073	Rapier jaw CPL., LHS, with vulkollan, fine serrated surface, 5mm	
13-C	72544R - LD2128/3	Rapier jaw CPL., LHS, with vulkollan, lengthways grooved surface, 5mm	
14-A	70688C – LD2129/1	Tungs. Carb. Ins., LHS, CPL, with vulkollan, smooth surface, 5mm	
14-B	70687Y – LD2129/2	Tungs. Carb. Ins., LHS, CPL, with vulkollan, serrated surface, 5mm (<i>70687V fine</i>)	
14-C	72544P - LD2129/3	Tungs. Carb. Ins., LHS, CPL, with vulkollan, lengthways grooved surface, 5mm (<i>70687V</i>)	
15-A	342823 – LD2130/1	Tungs. Carb. Ins., LHS, smooth surface, 5mm	
15-B	342825 – LD2130/2	Tungs. Carb. Ins., LHS, serrated surface, 5mm (<i>342826 fine</i>)	
15-C	348714 - LD2130/3	Tungs. Carb. Ins., LHS, lengthways grooved surface, 5mm	
16	342827 - LD2131	Vulkollan, LHS (3,5 x 5 x 15,5mm)	
17	LD2132	Rapier jaw body, LHS, 5mm	
18-A	LD2133/1	Rapier jaw CPL., LHS, with vulkollan, split smooth surface, 5mm	
18-B	LD2133/2	Rapier jaw CPL., LHS, with vulkollan, split serrated surface, 5mm	
18-C	LD2133/3	Rapier jaw CPL., LHS, with vulkollan, split lengthways grooved surface, 5mm	
19-A	LD2134/1	Tungs. Carb. Ins., LHS, CPL, with vulkollan, split smooth surface, 5mm	
19-B	LD2134/2	Tungs. Carb. Ins., LHS, CPL, with vulkollan, split serrated surface, 5mm	
19-C	LD2134/3	Tungs. Carb. Ins., LHS, CPL, with vulkollan, split lengthways grooved surface, 5mm	
20-A	LD2135/1	Tungs. Carb. Ins., LHS, CPL, with vulkollan, split smooth surface, 5mm	
20-B	LD2135/2	Tungs. Carb. Ins., LHS, CPL, with vulkollan, split serrated surface, 5mm	
20-C	LD2135/3	Tungs. Carb. Ins., LHS, CPL, with vulkollan, split lengthways grooved surface, 5mm	
21	71239X - LD2189	Rapier jaw CPL., LHS, with vulkollan, undulated surface, 5mm	
22	71239W - LD2190	Tungs. Carb. Ins. CPL., LHS, with vulkollan, undulated, 5mm	
23	345379 - LD2191	Tungs. Carb. Ins., LHS, undulated, 5mm	
24	345374 - LD2192	Vulkollan, LHS (5 x 2 x 16mm)	

25	345098 - LD2193	Countersunk screw (M3 x 8) (341050)	
26	311206 - LD2022	Nut, M3	
27	341914 – LD2023	Washer	
28	345187 - LD2194	Guide piece, LHS, black (343743, 345186)	
29	345188 - LD2195	Guide piece, LHS, light grey	
30	328321 – LD2028	Locking element	
31	70861H – LD2196	Clamping spring CPL., LHS	
32	769850 – LD2037	Stop piece, LHS	
33	338999 – LD2142	Oval head screw (M3x10)	
34	311208 - LD2014	Nut, M4	
35	301702 – LD2039	Washer	
36	707873 – LD2093	Clamping stud, LHS	
37	309758 - LD2031	Setscrew (M3x4)	
38	711576 - LD2032	Upper guide plate	
39	410826 – LD2033	Lower guide plate (0,1 x 6 x 14mm)	
40	345444 – LD2141	Vulkollan guide	
41	322842 – LD2034	Spring (1,1 x 6 x 64mm) (72026V with vulkollan)	
42	322843 – LD2035	Spring (1,1 x 6 x 50mm)	
43	322844 – LD2036	Spring (1,1 x 6 x 30mm)	
44	71829R - LD2217*	Carbon profile CPL., 9mm	
45	LD2218*	Carbon profile, 9mm	
46	71362K - LD2219/1	Toothed rack, 9mm L=160cm	
47	LD2198	Fitting piece, "I" form	
48	335102 – LD2148	Oval head screw (M4x10)	
49	322532 - LD2045	Oval head screw (M4x8)	
50	410301 - LD2048	Spring washer	
51	LD2220	Upper protecting sheet, 9mm	
52	LD2221	Lower protecting sheet, 9mm	
53	331943 - LD2222	Oval head screw (M5x8)	
54	311209 - LD2223	Nut, M5	
55	71310R - LD2224	Stop piece, 9mm	
56	339317 - LD2152	Guide piece	
57	311066 – LD2096	Hexagon screw (M4x10)	

T2, RHS, 9mm
71328K/71928X

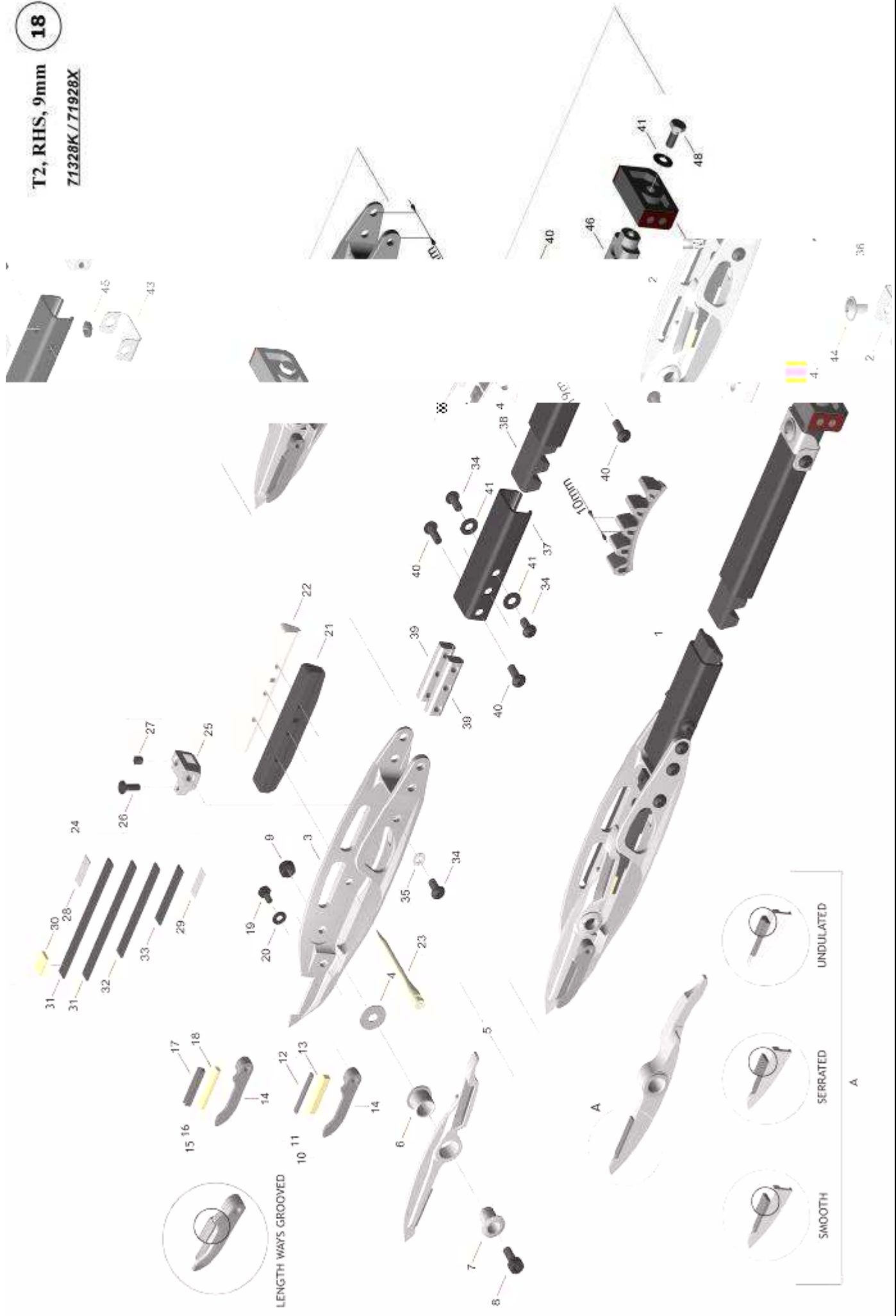

A

18	ORIGINAL – R.T.S CODES	DESCRIPTION	
1-A	71712Fce - LD2225/1	Rapier CPL., RHS, with vulkollan, smooth surface, ceramic	
1-B	71712Fcr - LD2225/2	Rapier CPL., RHS, with vulkollan, smooth surface, chrome	
1-C	71781Nce - LD2225/3	Rapier CPL., RHS, with vulkollan, serrated surface, ceramic	
1-D	71781Ncr - LD2225/4	Rapier CPL., RHS, with vulkollan, serrated surface, chrome	
1-E	72590A - LD2225/5	Rapier CPL., RHS, with vulkollan, lengthways grooved surface, ceramic	
1-F	LD2225/6	Rapier CPL., RHS, with vulkollan, lengthways grooved surface, chrome	
1-G	71781Wce - LD2225/7	Rapier CPL., RHS, with vulkollan, undulated surface, ceramic	
1-H	71781Wcr - LD2225/8	Rapier CPL., RHS, with vulkollan, undulated surface, chrome	
2-A	71328Kce - LD2226/1	Rapier head CPL., RHS, with vulkollan, smooth surface, ceramic	
2-B	71328Kcr - LD2226/2	Rapier head CPL., RHS, with vulkollan, smooth surface, chrome	
2-C	71328Pce - LD2226/3	Rapier head CPL., RHS, with vulkollan, serrated surface, ceramic	
2-D	71328Pcr - LD2226/4	Rapier head CPL., RHS, with vulkollan, serrated surface, chrome	
2-E	72545M - LD2226/5	Rapier head CPL., RHS, with vulkollan, lengthways grooved surface, ceramic	
2-F	LD2226/6	Rapier head CPL., RHS, with vulkollan, lengthways grooved surface, chrome	
2-G	71624Hce - LD2226/7	Rapier head CPL., RHS, with vulkollan, undulated surface, ceramic	
2-H	71624Hcr - LD2226/7	Rapier head CPL., RHS, with vulkollan, undulated surface, chrome	
3-A	71928Xce - LD2227/1	Rapier head body, RHS, 9mm, ceramic	
3-B	71928Xcr - LD2227/1	Rapier head body, RHS, 9mm, chrome	
4	334554 – LD2119	Centring washer	
5-A	71247B - LD2202/1	Clamp lever CPL., RHS, smooth surface	
5-B	71297W - LD2202/2	Clamp lever CPL., RHS, serrated surface	
5-C	71340W - LD2202/3	Clamp lever CPL., RHS, undulated surface	
6	LD2122	Centring bush	
7	333036 - LD2101	Bush	
8	333318 - LD2102	Socket head screw (M4x10)	
9	311208 - LD2014	Nut, M4	
10-A	70985L – LD2203/1	Rapier jaw CPL., RHS, with vulkollan, smooth surface	
10-B	71203M – LD2203/2	Rapier jaw CPL., RHS, with vulkollan, serrated surface	
	70985V - LD6014	Rapier jaw CPL., RHS, with vulkollan, fine serrated surface	
10-C	75545P – LD2203/3	Rapier jaw CPL., RHS, with vulkollan, lengthways grooved surface	
11-A	70879T – LD2204/1	Tungs. Carb. Ins., RHS, CPL, with vulkollan, smooth surface	
11-B	70940Y – LD2204/2	Tungs. Carb. Ins., RHS, CPL, with vulkollan, serrated surface (70941G fine serrated)	
11-C	72545N – LD2204/3	Tungs. Carb. Ins., RHS, CPL, with vulkollan, lengthways grooved surface	
12-A	343904 – LD2205/1	Tungs. Carb. Ins., RHS, smooth surface	

12-B	344104 – LD2205/2	Tungs. Carb. Ins., RHS, serrated surface (<i>344103 fine serrated</i>)	
12-C	348715 – LD2205/3	Tungs. Carb. Ins., RHS, lengthways grooved surface,	
13	343905 – LD2206	Vulkollan, LHS (3,5 x 3,5 x 20mm)	
14	LD2207	Rapier jaw body, RHS	
15	71240D - LD2208	Rapier jaw CPL., RHS, with vulkollan, undulated surface	
16	71240F - LD2209	Tungs. Carb. Ins. CPL., RHS, with vulkollan, undulated	
17	345382 - LD2210	Tungs. Carb. Ins., RHS, undulated	
18	345381 - LD2211	Vulkollan, LHS (2 x 3,5 x 22mm)	
19	310943 – LD2163	Hexagon screw (M3x8)	
20	341914 – LD2023	Washer	
21	343743 - LD2194	Guide piece, RHS, black (345187, 345186)	
22	345188 – LD2195	Guide piece, RHS, light grey	
23	328321 – LD2028	Locking element	
24	70860K – LD2212	Clamping spring CPL., RHS	
25	70744E – LD2213	Clamping stud, RHS	
26	311884 – LD2235	Hexagon screw (M3x10)	
27	309767 – LD2071	Setscrew (M4x4)	
28	711576 – LD2032	Upper guiding plate (0,5 x 6 x 14mm)	
29	410826 – LD2033	Lower guide plate (0,1 x 6 x 14mm)	
30	345444 – LD2141	Vulkollan guide	
31	322842 – LD2034	Spring (1,1 x 6 x 64mm) (<i>72026V with vulkollan</i>)	
32	322843 – LD2035	Spring (1,1 x 6 x 50mm)	
33	322844 – LD2036	Spring (1,1 x 6 x 30mm)	
34	322532 - LD2045	Oval head screw (M4x8)	
35	410394 - LD2170	Washer	
36	71829R - LD2217*	Carbon profile CPL., 9mm	
37	LD2218*	Carbon profile, 9mm	
38	71362k - LD2219	Toothed rack, 9mm <i>L=160cm</i>	
39	LD2198	Fitting piece, "I" form	
40	335102 – LD2148	Oval head screw (M4x10)	
41	410301 - LD2048	Spring washer	
42	LD2220	Upper protecting sheet, 9mm	
43	LD2221	Lower protecting sheet, 9mm	
44	331943 - LD2222	Oval head screw (M5x8)	
45	311209 - LD2223	Nut, M5	
46	71310R - LD2224	Stop piece, 9mm	
47	339317 - LD2152	Guide piece	
48	311066 – LD2096	Hexagon screw (M4x10)	

T2, LHS, 10mm 19

71617F / 71617G

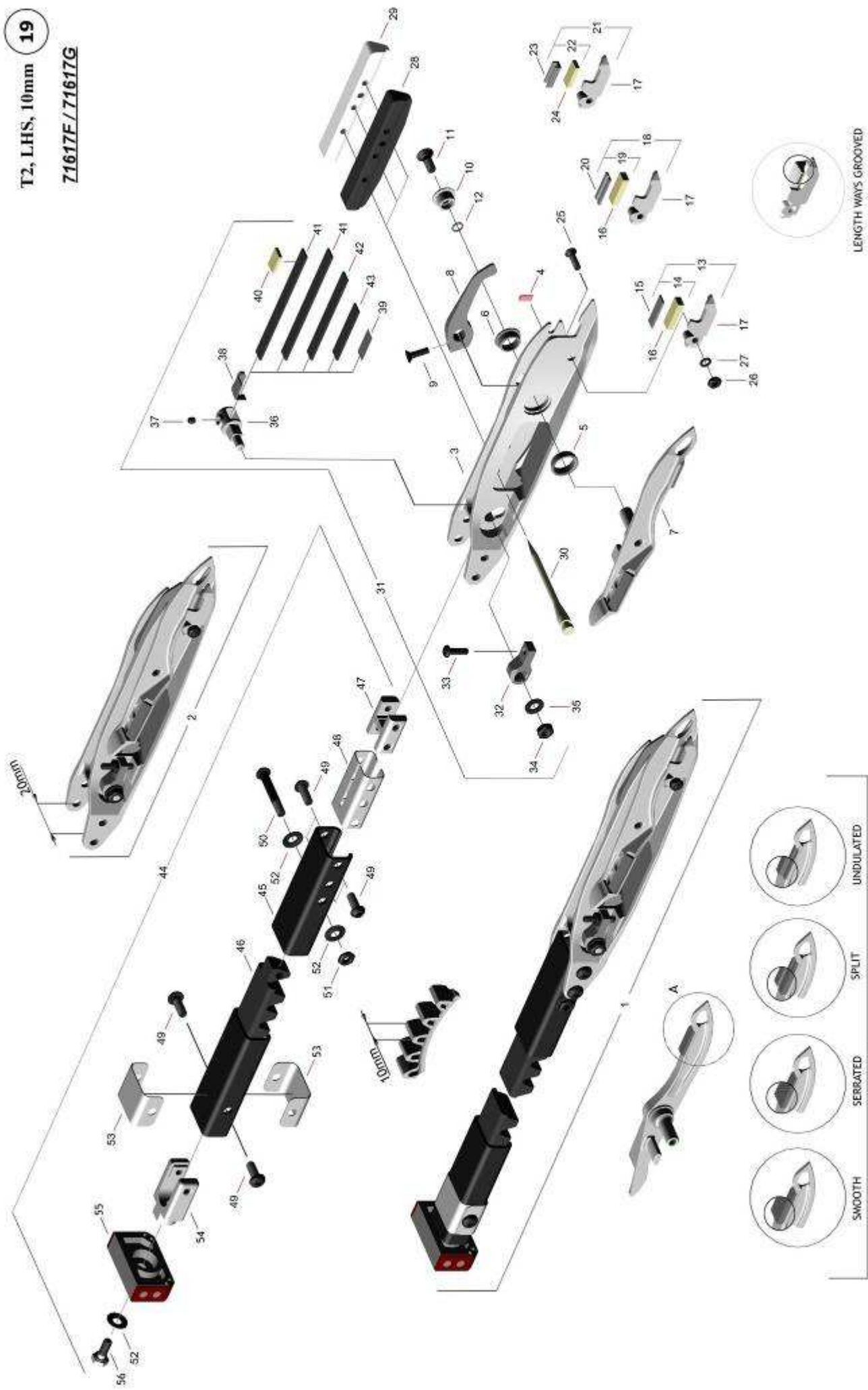

LENGTHWAYS GROOVED

UNDATED

SPLIT

SERRATED

SMOOTH

A

19	ORIGINAL – R.T.S CODES	DESCRIPTION	
1-A	71663Fce - LD2228/1	Rapier CPL., LHS, with vulkollan, smooth surface, ceramic	
1-B	71663Fcr - LD2228/2	Rapier CPL., LHS, with vulkollan, smooth surface, chrome	
1-C	71782Fce - LD2228/3	Rapier CPL., LHS, with vulkollan, serrated surface, ceramic	
1-D	71782cr - LD2228/4	Rapier CPL., LHS, with vulkollan, serrated surface, chrome	
1-E	71591Xce - LD2228/5	Rapier CPL., LHS, with vulkollan, lengthways grooved surface, ceramic	
1-F	71591Xcr - LD2228/6	Rapier CPL., LHS, with vulkollan, lengthways grooved surface, chrome	
1-G	LD2228/7	Rapier CPL., LHS, with vulkollan, split, smooth surface, ceramic	
1-H	LD2228/8	Rapier CPL., LHS, with vulkollan, split, smooth surface, chrome	
1-I	LD2228/9	Rapier CPL., LHS, with vulkollan, split, serrated surface, ceramic	
1-J	LD2228/10	Rapier CPL., LHS, with vulkollan, split, serrated surface, chrome	
1-K	LD2228/11	Rapier CPL., LHS, with vulkollan, split, lengthways grooved surface, ceramic	
1-L	LD2228/12	Rapier CPL., LHS, with vulkollan, split, lengthways grooved surface, chrome	
1-M	71782Hce - LD2228/13	Rapier CPL., LHS, with vulkollan, undulated surface, ceramic	
1-N	71782Hcr - LD2228/14	Rapier CPL., LHS, with vulkollan, undulated surface, chrome	
2-A	71617Fce - LD2215/1	Rapier head CPL., LHS, with vulkollan, smooth surface, ceramic	
2-B	71617Fcr - LD2215/2	Rapier head CPL., LHS, with vulkollan, smooth surface, chrome	
2-C	71782Gce - LD2229/3	Rapier head CPL., LHS, with vulkollan, serrated surface, ceramic	
2-D	71782Gcr - LD2229/4	Rapier head CPL., LHS, with vulkollan, serrated surface, chrome	
2-E	72592Ace - LD2229/5	Rapier head CPL., LHS, with vulkollan, lengthways grooved surface, ceramic	
2-F	72592Acr - LD2229/6	Rapier head CPL., LHS, with vulkollan, lengthways grooved surface, chrome	
2-G	LD2229/7	Rapier head CPL., LHS, with vulkollan, split, smooth surface, ceramic	
2-H	LD2229/8	Rapier head CPL., LHS, with vulkollan, split, smooth surface, chrome	
2-I	LD2229/9	Rapier head CPL., LHS, with vulkollan, split, serrated surface, ceramic	
2-J	LD2229/10	Rapier head CPL., LHS, with vulkollan, split, serrated surface, chrome	
2-K	LD2229/11	Rapier head CPL., LHS, with vulkollan, split, lengthways grooved surface, ceramic	
2-L	LD2229/12	Rapier head CPL., LHS, with vulkollan, split, lengthways grooved surface, chrome	
2-M	71635Cce - LD2229/13	Rapier head CPL., LHS, with vulkollan, undulated surface, ceramic	
2-N	71635Ccr - LD2229/14	Rapier head CPL., LHS, with vulkollan, undulated surface, chrome	
3-A	71617Gce – LD2230/1	Rapier head body, LHS, 8mm, ceramic	
3-B	71617Gcr – LD2230/2	Rapier head body, LHS, 8mm, chrome	
4	450124 – LD2180	Ceramic piece	
5	LD2181	Bush, 10mm	
6	LD2182	Bush, 8mm	
7-A	71246V – LD2183/1	Clamp lever CPL., LHS, smooth surface	

7-B	71297P – LD2183/2	Clamp lever CPL., LHS, serrated surface	
7-C	LD2183/3	Clamp lever CPL., LHS, split, smooth surface	
7-D	LD2183/4	Clamp lever CPL., LHS, split, serrated surface	
7-E	71340N – LD2183/5	Clamp lever CPL., LHS, undulated surface	
8	70861E – LD2184	Line feed lever	
9	345098 – LD2185	Countersunk screw (M3x8)	
10	341167 – LD2186	Special bush	
11	345105 – LD2187	Countersunk screw (M4x8)	
12-A	70299X – LD2188/1	Adjustment washer (4,0 x 6,0 x 0,1mm)	
12-B	70299Y – LD2188/2	Adjustment washer (4,0 x 6,0 x 0,3mm)	
12-C	70300A – LD2188/3	Adjustment washer (4,0 x 6,0 x 0,5mm)	
13-A	71199G – LD2128/1	Rapier jaw CPL., LHS, with vulkollan, smooth surface, 5mm	
13-B	71199K – LD2128/2	Rapier jaw CPL., LHS, with vulkollan, serrated surface, 5mm	
	71199H - LDLD6073	Rapier jaw CPL., LHS, with vulkollan, fine serrated surface, 5mm	
13-C	72544R - LD2128/3	Rapier jaw CPL., LHS, with vulkollan, lengthways grooved surface, 5mm	
14-A	70688C – LD2129/1	Tungs. Carb. Ins., LHS, CPL, with vulkollan, smooth surface, 5mm	
14-B	70687Y – LD2129/2	Tungs. Carb. Ins., LHS, CPL, with vulkollan, serrated surface, 5mm (<i>70687V fine</i>)	
14-C	72544P - LD2129/3	Tungs. Carb. Ins., LHS, CPL, with vulkollan, lengthways grooved surface, 5mm	
15-A	342823 – LD2130/1	Tungs. Carb. Ins., LHS, smooth surface, 5mm	
15-B	342825 – LD2130/2	Tungs. Carb. Ins., LHS, serrated surface, 5mm (<i>342826 fine</i>)	
15-C	348714 - LD2130/3	Tungs. Carb. Ins., LHS, lengthways grooved surface, 5mm	
16	342827 - LD2131	Vulkollan, LHS (3,5 x 5 x 15,5mm)	
17	LD2132	Rapier jaw body, LHS, 5mm	
18-A	LD2133/1	Rapier jaw CPL., LHS, with vulkollan, split smooth surface, 5mm	
18-B	LD2133/2	Rapier jaw CPL., LHS, with vulkollan, split serrated surface, 5mm	
18-C	LD2133/3	Rapier jaw CPL., LHS, with vulkollan, split lengthways grooved surface, 5mm	
19-A	LD2134/1	Tungs. Carb. Ins., LHS, CPL, with vulkollan, split smooth surface, 5mm	
19-B	LD2134/2	Tungs. Carb. Ins., LHS, CPL, with vulkollan, split serrated surface, 5mm	
19-C	LD2134/3	Tungs. Carb. Ins., LHS, CPL, with vulkollan, split lengthways grooved surface, 5mm	
20-A	LD2135/1	Tungs. Carb. Ins., LHS, CPL, with vulkollan, split smooth surface, 5mm	
20-B	LD2135/2	Tungs. Carb. Ins., LHS, CPL, with vulkollan, split serrated surface, 5mm	
20-C	LD2135/3	Tungs. Carb. Ins., LHS, CPL, with vulkollan, split lengthways grooved surface, 5mm	
21	71239X - LD2189	Rapier jaw CPL., LHS, with vulkollan, undulated surface, 5mm	
22	71239W - LD2190	Tungs. Carb. Ins. CPL., LHS, with vulkollan, undulated, 5mm	
23	345379 - LD2191	Tungs. Carb. Ins., LHS, undulated, 5mm	
24	345374 - LD2192	Vulkollan, LHS (5 x 2 x 16mm)	

25	345098 - LD2193	Countersunk screw (M3 x 8) (341050)	
26	311206 - LD2022	Nut, M3	
27	341914 - LD2023	Washer	
28	345187 - LD2194	Guide piece, LHS, black (343743, 345186)	
29	345188 - LD2195	Guide piece, LHS, light grey	
30	328321 - LD2028	Locking element	
31	70861H - LD2196	Clamping spring CPL., LHS	
32	769850 - LD2037	Stop piece, LHS	
33	338999 - LD2142	Oval head screw (M3x10)	
34	311208 - LD2014	Nut, M4	
35	301702 - LD2039	Washer	
36	707873 - LD2093	Clamping stud, LHS	
37	309758 - LD2031	Setscrew (M3x4)	
38	711576 - LD2032	Upper guide plate	
39	410826 - LD2033	Lower guide plate (0,1 x 6 x 14mm)	
40	345444 - LD2141	Vulkollan guide	
41	322842 - LD2034	Spring (1,1 x 6 x 64mm) (72026V with vulkollan)	
42	322843 - LD2035	Spring (1,1 x 6 x 50mm)	
43	322844 - LD2036	Spring (1,1 x 6 x 30mm)	
47	788452 - LD2175	Fitting piece, "H" form	
48	853316 - LD2043	Adaptor	
49	322532 - LD2045	Oval head screw (M4x8)	
50	322502 - LD2046	Oval head screw (M4x25)	
51	311209 - LD2047	Nut, M4 (311209)	
52	410301 - LD2048	Spring washer	
53	853329 - LD2049	Protecting sheet, 10mm	
54	334982 - LD2094	Stop piece, 10mm, "U" form	
55	339317 - LD2095	Guide piece	
56	311066 - LD2096	Hexagon screw (M4x10)	

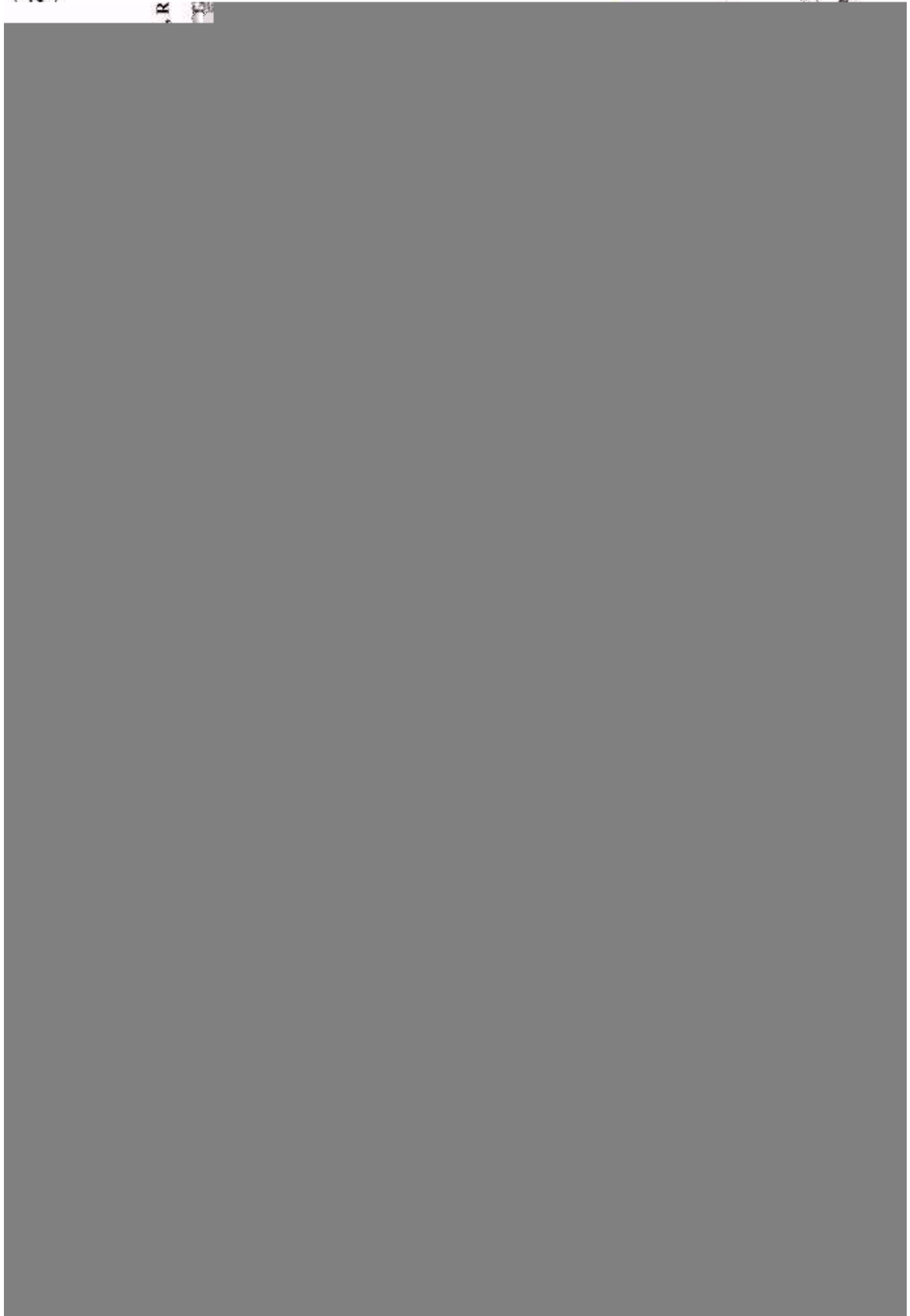

20	ORIGINAL – R.T.S CODES	DESCRIPTION	
1-A	LD2231/1	Rapier CPL., RHS, with vulkollan, smooth surface, ceramic	
1-B	LD2231/2	Rapier CPL., RHS, with vulkollan, smooth surface, chrome	
1-C	71782Ace - LD2231/3	Rapier CPL., RHS, with vulkollan, serrated surface, ceramic	
1-D	71782Acr - LD2231/4	Rapier CPL., RHS, with vulkollan, serrated surface, chrome	
1-E	72592Bce - LD2231/5	Rapier CPL., RHS, with vulkollan, lengthways grooved surface, ceramic	
1-F	72592Bcr - LD2231/6	Rapier CPL., RHS, with vulkollan, lengthways grooved surface, chrome	
1-G	71782Cce - LD2231/7	Rapier CPL., RHS, with vulkollan, undulated surface, ceramic	
1-H	71782Ccr - LD2231/8	Rapier CPL., RHS, with vulkollan, undulated surface, chrome	
2-A	71617Lce - LD2226/1	Rapier head CPL., RHS, with vulkollan, smooth surface, ceramic	
2-B	71617Lcr - LD2226/1	Rapier head CPL., RHS, with vulkollan, smooth surface, chrome	
2-C	71782Bce - LD2232/3	Rapier head CPL., RHS, with vulkollan, serrated surface, ceramic	
2-D	71782Bcr - LD2232/4	Rapier head CPL., RHS, with vulkollan, serrated surface, chrome	
2-E	72592Bce - LD2232/5	Rapier head CPL., RHS, with vulkollan, lengthways grooved surface, ceramic	
2-F	72592Bcr - LD2232/6	Rapier head CPL., RHS, with vulkollan, lengthways grooved surface, chrome	
2-G	71635Ece - LD2232/7	Rapier head CPL., RHS, with vulkollan, undulated surface, ceramic	
2-H	71635Ecr - LD2232/8	Rapier head CPL., RHS, with vulkollan, undulated surface, chrome	
3-A	71617Hce - LD2233/1	Rapier head body, RHS, 10mm, ceramic	
3-B	71617Hcr - LD2233/2	Rapier head body, RHS, 10mm, chrome	
4	334554 – LD2119	Centring washer	
5-A	71247B - LD2202/1	Clamp lever CPL., RHS, smooth surface	
5-B	71297W - LD2202/2	Clamp lever CPL., RHS, serrated surface	
5-C	71340W - LD2202/3	Clamp lever CPL., RHS, undulated surface	
6	LD2122	Centring bush	
7	333036 - LD2101	Bush	
8	333318 - LD2102	Socket head screw (M4x10)	
9	311208 - LD2014	Nut, M4	
10-A	70985L – LD2203/1	Rapier jaw CPL., RHS, with vulkollan, smooth surface	
10-B	71203M – LD2203/2	Rapier jaw CPL., RHS, with vulkollan, serrated surface	
	70985V - LD6014	Rapier jaw CPL., RHS, with vulkollan, fine serrated surface	
10-C	75545P – LD2203/3	Rapier jaw CPL., RHS, with vulkollan, lengthways grooved surface	
11-A	70879T – LD2204/1	Tungs. Carb. Ins., RHS, CPL, with vulkollan, smooth surface	
11-B	70940Y – LD2204/2	Tungs. Carb. Ins., RHS, CPL, with vulkollan, serrated surface (70941G fine serrated)	
11-C	72545N – LD2204/3	Tungs. Carb. Ins., RHS, CPL, with vulkollan, lengthways grooved surface	
12-A	343904 – LD2205/1	Tungs. Carb. Ins., RHS, smooth surface	
12-B	344104 – LD2205/2	Tungs. Carb. Ins., RHS, serrated surface (344103 fine serrated)	

12-C	348715 – LD2205/3	Tungs. Carb. Ins., RHS, lengthways grooved surface,	
13	343905 – LD2206	Vulkollan, LHS (3,5 x 3,5 x 20mm)	
14	LD2207	Rapier jaw body, RHS	
15	71240D - LD2208	Rapier jaw CPL., RHS, with vulkollan, undulated surface	
16	71240F - LD2209	Tungs. Carb. Ins. CPL., RHS, with vulkollan, undulated	
17	345382 - LD2210	Tungs. Carb. Ins., RHS, undulated	
18	345381 - LD2211	Vulkollan, LHS (2 x 3,5 x 22mm)	
19	310943 – LD2163	Hexagon screw (M3x8)	
20	341914 – LD2023	Washer	
21	343743 - LD2194	Guide piece, RHS, black (345187, 345186)	
22	345188 – LD2195	Guide piece, RHS, light grey	
23	328321 – LD2028	Locking element	
24	70860K – LD2212	Clamping spring CPL., RHS	
25	70744E – LD2213	Clamping stud, RHS	
26	311884 – LD2235	Hexagon screw (M3x10)	
27	309767 – LD2071	Setscrew (M4x4)	
28	711576 – LD2032	Upper guiding plate (0,5 x 6 x 14mm)	
29	410826 – LD2033	Lower guide plate (0,1 x 6 x 14mm)	
30	345444 – LD2141	Vulkollan guide	
31	322842 – LD2034	Spring (1,1 x 6 x 64mm) <i>(72026V with vulkollan)</i>	
32	322843 – LD2035	Spring (1,1 x 6 x 50mm)	
33	322844 – LD2036	Spring (1,1 x 6 x 30mm)	
34	322532 - LD2045	Oval head screw (M4x8)	
35	410394 - LD2170	Washer	
39	768452 - LD2175	Fitting piece, "H" form, 10mm	
40	853316 - LD2043	Adaptor	
41	322532 - LD2045	Oval head screw (M4x8)	
42	322502 - LD2046	Oval head screw (M4x25)	
43	322001 - LD2047	Nut, M4	
44	410301 - LD2048	Spring washer	
45	853329 - LD2049	Protection sheet, 10mm	
46	334982 - LD2094	Stop piece, 10mm, "U" form	
47	339317 – LD2095	Guide piece	
48	311066 – LD2096	Hexagon screw (M4x10)	

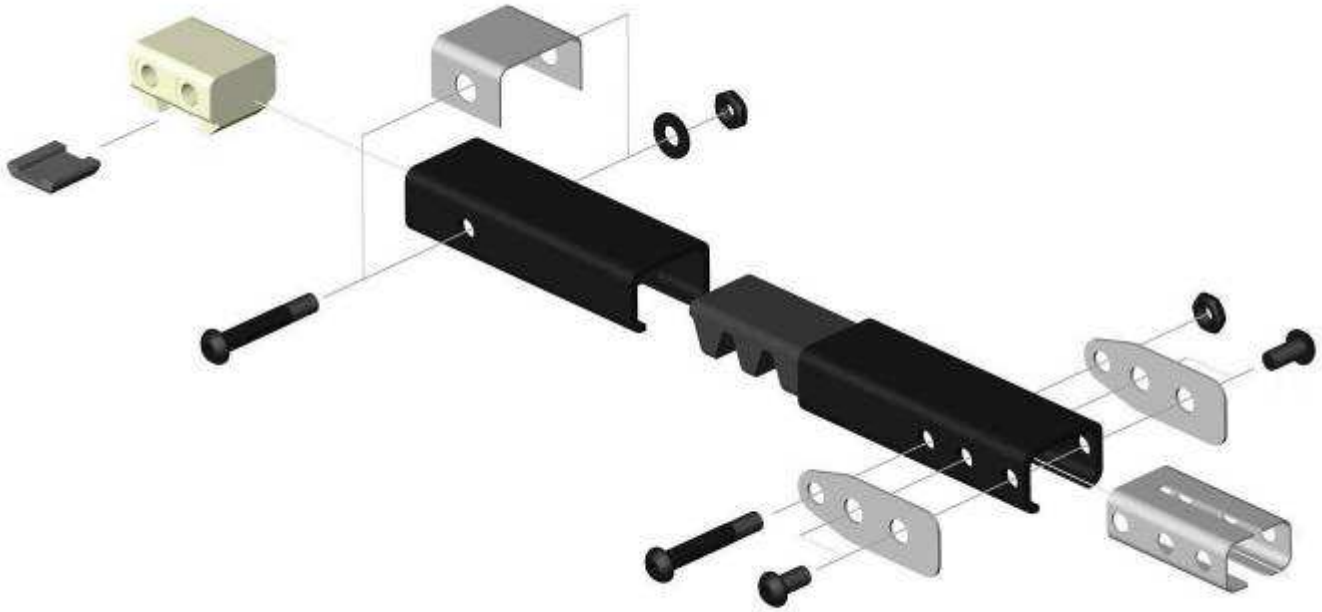

GTV MODEL - COMPLETE CARBON PROFILES

ORIGINAL CODE	R.T.S CODE	LOOM WIDTH	ROD WIDTH	
787554	GTV160C/L	160	1120	
787555	GTV170C/L	170	1170	
787556	GTV180C/L	180	1220	
787557	GTV190C/L	190	1270	
787558	GTV200C/L	200	1320	
787559	GTV210C/L	210	1370	
787560	GTV220C/L	220	1420	
787561	GTV230C/L	230	1470	
787562	GTV240C/L	240	1520	
787563	GTV250C/L	250	1570*	
787564	GTV260C/L	260	1620*	
787565	GTV270C/L	270	1670*	
787566	GTV280C/L	280	1720*	
787567	GTV290C/L	290	1770*	
787568	GTV300C/L	300	1820*	
787570	GTV320C/L	320	1920*	
787571	GTV330C/L	330	1970*	
787572	GTV340C/L	340	2020*	
787573	GTV350C/L	350	2070*	
787574	GTV360C/L	360	2120*	
787575	GTV380C/L	380	2220*	
787576	GTV400C/L	400	2320*	

* Jointed rack

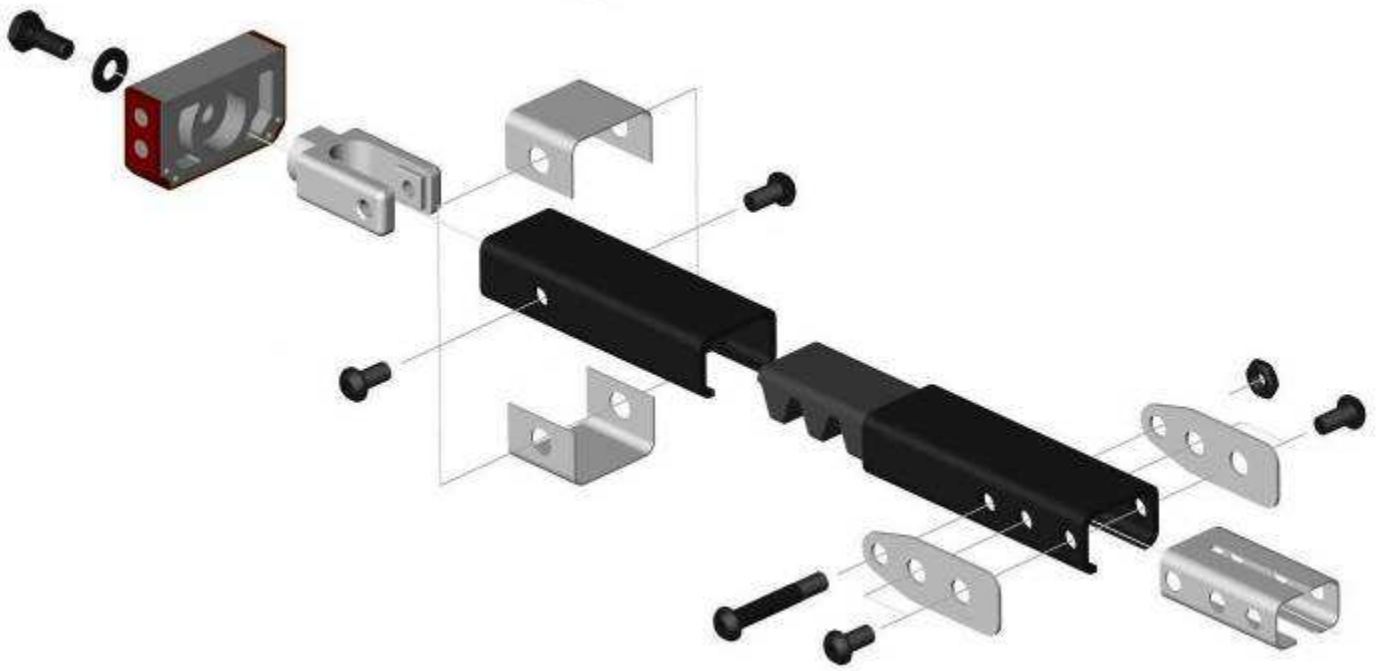

HTV MODEL - COMPLETE CARBON PROFILES

ORIGINAL CODE	R.T.S CODE	LOOM WIDTH	ROD WIDTH	
764741	HTV160C/L	160	1050	
764742	HTV170C/L	170	1100	
764743	HTV180C/L	180	1150	
764744	HTV190C/L	190	1200	
764745	HTV200C/L	200	1250	
764746	HTV210C/L	210	1300	
764747	HTV220C/L	220	1350	
764748	HTV230C/L	230	1400	
764749	HTV240C/L	240	1450	
764750	HTV250C/L	250	1500	
764751	HTV260C/L	260	1550*	
764752	HTV270C/L	270	1600*	
764753	HTV280C/L	280	1650*	
764754	HTV290C/L	290	1700*	
764756	HTV300C/L	300	1750*	
764757	HTV320C/L	320	1850*	
764758	HTV330C/L	330	1900*	
764759	HTV340C/L	340	1950*	
764760	HTV350C/L	350	2000*	
764761	HTV360C/L	360	2050*	
764762	HTV380C/L	380	2150*	
764763	HTV400C/L	400	2200*	

* Jointed rack



* !)

	% %))	
	* "			
	* "			
	* "	#		
	* "			
	* "			
	* "			
	* "		"	
	* "		"	
	* "	"	!	
	* "	!	!	
	* "			
	* "			
	* "	#		
	* "			
	* "		#	
	* "			
	* "			
	* "	"		
	* "	!		
	* "			
	* "	#		
	* "	"		

* !)

	% %))	
	* "		!	
	* "			
	* "	#	!	
	* "			
	* "		!	
	* "			
	* "		!	
	* "		"	
	* "	"	"!	
	* "	!	!	
	* "		!!	
	* "			
	* "	#	!	
	* "			
	* "		!	
	* "		#!	
	* "			
	* "	"	!	
	* "	!		
	* "		!	
	* "	#	!	
	* "	"		

RAW RACK FOR ROD *HTV – GTV (10mm)*

CODE	DESCRIPTION	PRICE
<i>CRD1500</i>	Raw rack for HTV or GTV (not finished)	

RACK FOR ROD LOOM *PTV (9mm)*

CODE	DESCRIPTION	PRICE
<i>CRDP1500</i>	Raw rack for PTV – PTS	