



Rua: São Vito, 2161, Santa Cruz, Americana-SP, Cep: 13477-350, Tel. (19) 3621-6721
web: www.vrtextil.com.br e-mail: vr.textil@hotmail.com



Consultoria Textil Import
Export Vendas Manutenção

RICAMBI PER TELAI VAMATEX (Intercambiabili con l'originale)
VAMATEX LOOMS SPARE PARTS (Interchangeable with originals)

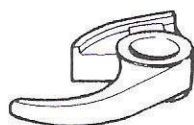

VA101

2526174

Levetta per pinza traente
Lever for rh gripper



VA102

2150042

Perno per levetta
Pin for lever

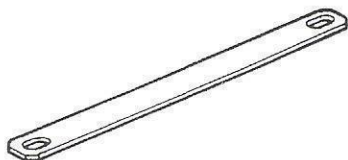

VA103

2148132

Lamina in carbonio
Carbon plate

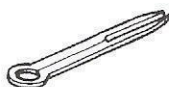

VA104

2563116

Molletta di tenuta
Spring

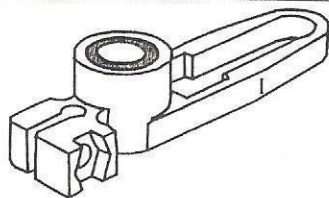

VA105

9340073

Corpo oscillante con bussola
Swinging piece with bush



VA106

2558012

Pattino per corpo oscillante
Sliding block for swinging piece

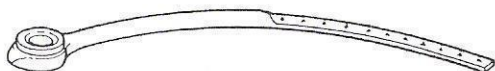

VA107

2582026

Freccia con bussola
Finger with bush



Consultoria Textil Import
Export Vendas Manutenção

RICAMBI PER TELAI VAMATEX (Intercambiabili con l'originale)
VAMATEX LOOMS SPARE PARTS (Interchangeable with originals)

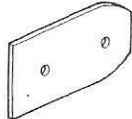

VA108

2548266

Piastrina per nastro
Plate for point of tape

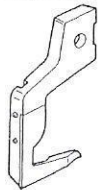

VA109

2520004

Lama fissa
Fix blade

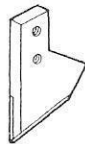

VA110

2520002

Lama mobile
Mobile blade

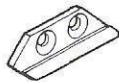

VA111

2522020

Lama per taglierina
Blade for cutter

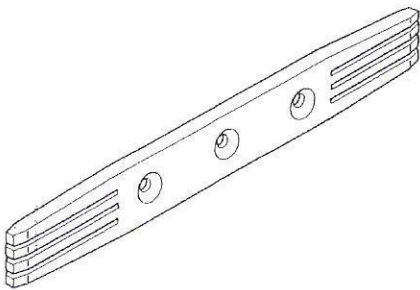

VA112

2569056

Pattino apripinza
Gripper opening sliding block

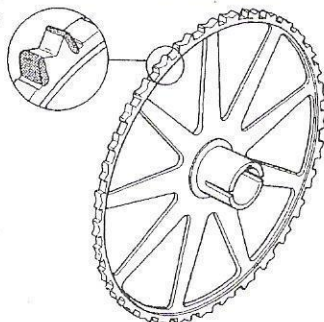

VA113

2398518.1

Dentarella 401 con dente metallico
Toothed wheel 401 with metallic cap

**RICAMBI PER TELAI VAMATEX (Intercambiabili con l'originale)
VAMATEX LOOMS SPARE PARTS (Interchangeable with originals)**

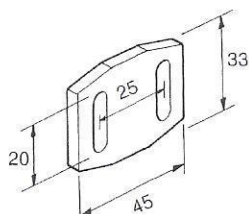

VA114

2569024

Piastrina apertura pinza port.
LH gripper opening plate

C 201-C 301-SP 151-SP 251-C 401

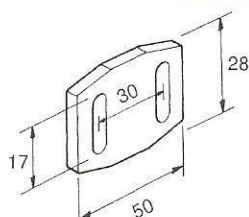

VA115

2569054

Piastra di apertura P 1001
Opening plate for P 1001

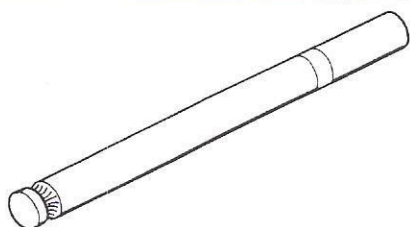

VA116

2302014

Albero comando presentat.
Weft selector drive shaft

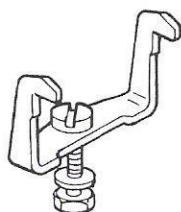

VA117

2523018

Gancio guidanastro
Tape guiding hook

C 401-P 401-S

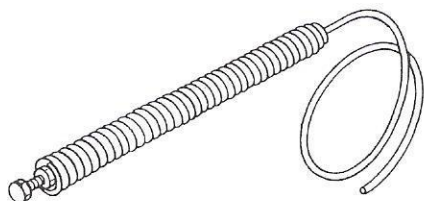

VA118

9281605	H. 1600	9283017	H. 3000
9281917	H. 1900	9283217	H. 3200
9282117	H. 2100	9283417	H. 3400
9282317	H. 2300	9283618	H. 3600
9282617	H. 2600	9283817	H. 3800

Fune comando splitz
Leno device drive rope

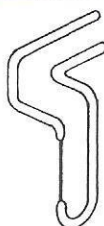

VA119

2507008

Taglio termico
Heat cutter

401-1001

RICAMBI PER TELAI VAMATEX (Intercambiabili con l'originale)
VAMATEX LOOMS SPARE PARTS (Interchangeable with originals)

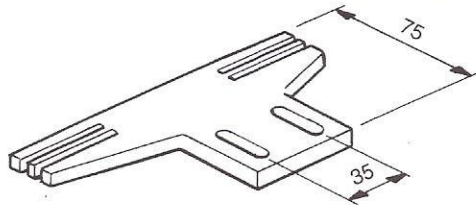

VA120

2569032

Piastra apripinza
Gripper opening plate

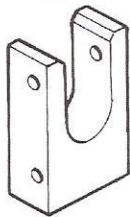

VA121

2548004

Bussola per avvolgipezza
Bush for cloth roller

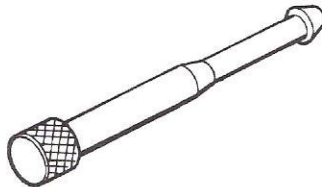

VA122

2100168

Perno per bussola avvolgipezza
Pin for cloth roller bush

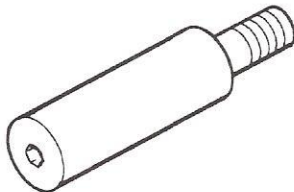

VA123

2130002

Perno tendicatena
Chain tightener pin



VA124

2148162

Bussola per pinza
Bush for gripper

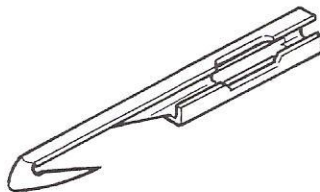

VA125

2522024

Gancio pinza traente
Rh gripper hook

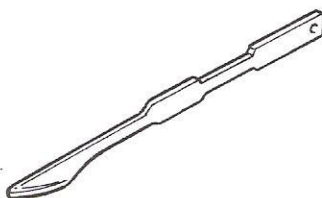

VA126

2550020

Cursore per pinza
Gripper slide

2580302

Cursore per pinza per trame parallele
Gripper slide for parallel wefts



**Consultoria Textil Import
Export Vendas Manutenção**

**RICAMBI PER TELAI VAMATEX (Intercambiabili con l'originale)
VAMATEX LOOMS SPARE PARTS (Interchangeable with originals)**

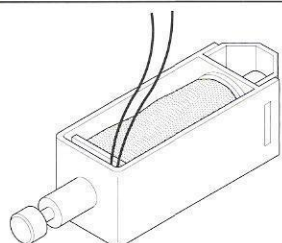

VA127

2589012

Elettromagnete per presentatrici
Electromagnet for weft selector

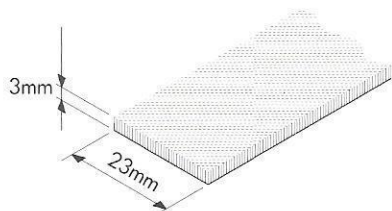

VA128

2729798÷2729814

Panno verde adesivo (bobina da 50mt.)
Adhesive green cloth (50m - roll)

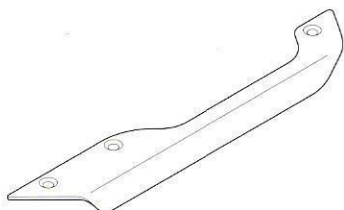

VA129

2548416

Aletta di guida per pinza portante P.401 S
Lh gripper wing for P401 S loom

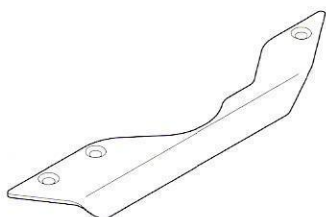

VA130

2548418

Aletta di guida per pinza traente P.401 S
Rh gripper wing for P401 S loom

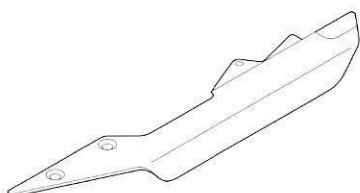

VA131

2548412

Aletta di guida per pinza portante P.1001
Lh gripper wing for P1001 loom

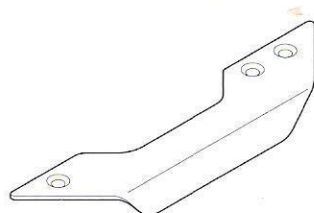

VA132

2548406

Aletta di guida per pinza traente P.1001
Rh gripper wing for P1001 loom



**RICAMBI PER TELAI VAMATEX (Intercambiabili con l'originale)
VAMATEX LOOMS SPARE PARTS (Interchangeable with originals)**

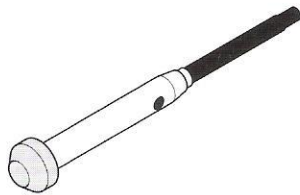

VA133

2548228

Nucleo per elettromagnete
Electromagnet core



VA134

2878008

Testo per nucleo
Core head

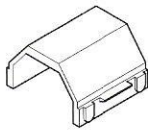

VA135

2878006

Fermo per nucleo
Core stopper

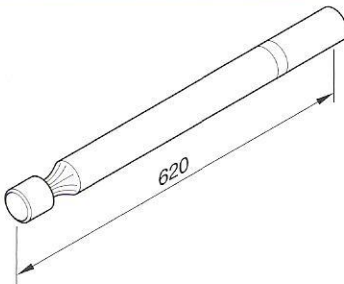

VA136

2302018

Albero comando presentatrice per 201
Weft selector drive shaft-201

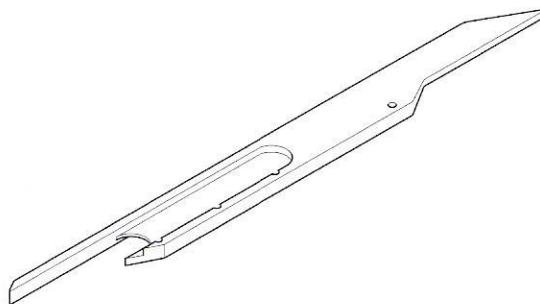

VA137

2508100B

Punta nastro traente sp. 4 mm
RH tape point

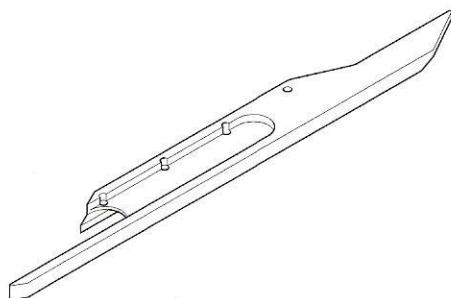

VA138

2508096.B

Punta nastro portante sp. 4 mm
LH tape point



Consultoria Textil Import
Export Vendas Manutenção

RICAMBI PER TELAI VAMATEX (Intercambiabili con l'originale)
VAMATEX LOOMS SPARE PARTS (Interchangeable with originals)

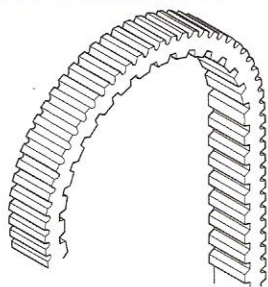

VA139

2398026

Cinghia svolgitore
Dereeling device belt

C401-P1001

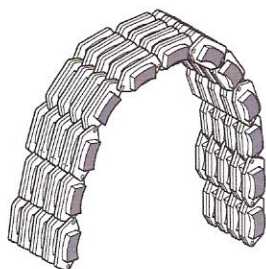

VA140

0428004

Catena variatore L 231
Variator chain

401÷9000 PLUS

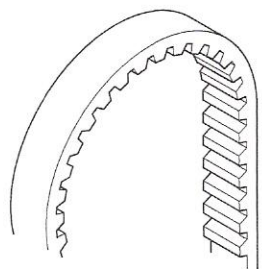

VA141

0423020

Cinghia per motore
Motor belt

1764 RHP 14-40 HPR

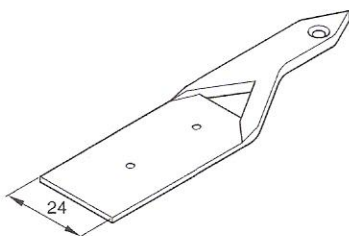

VA142

2508162

Pattino sottopinza per telaio 401
Sliding block for loom 401

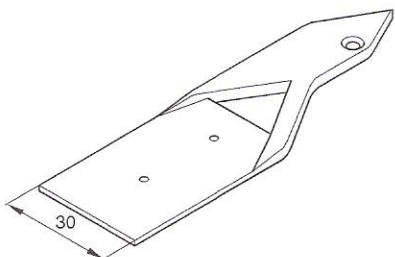

VA143

2508194

Pattino sottopinza per telaio 201
Sliding block for loom 201



RICAMBI PER TELAI VAMATEX (Intercambiabili con l'originale)
VAMATEX LOOMS SPARE PARTS (Interchangeable with originals)

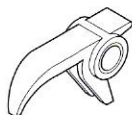

VA144

9120236

Leva per pinza DX P-1001
RH Lever assembly P-1001

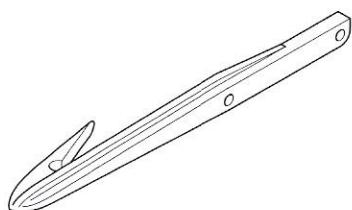

VA145

2522076

Gancio per pinza DX P-1001
Hook for RH gripper P-1001

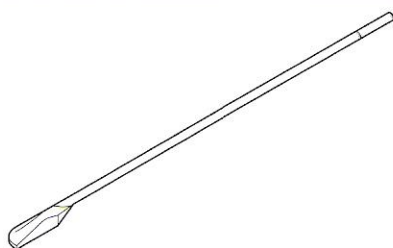

VA146

2583032

Cursore per pinza DX P-1001
Slider for RH gripper P-1001

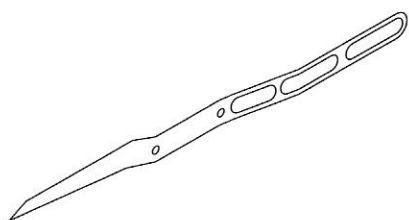

VA147

2503008

Lamina per pinza DX P-1001
Lamel for RH gripper P-1001

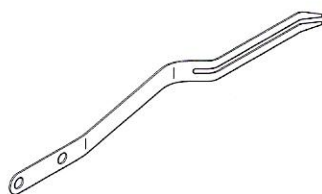

VA148

2563222

Lamina di tenuta trama P-1001
Plate for weft holding LH P-1001

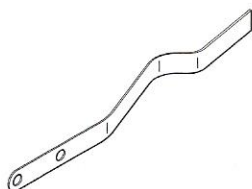

VA149

2583038

Lamina di pressione P-1001
Pressure lame P-1001

**RICAMBI PER TELAI VAMATEX (Intercambiabili con l'originale)
VAMATEX LOOMS SPARE PARTS (Interchangeable with originals)**

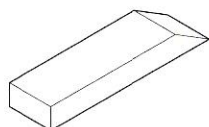

VA150

2509090

Pattino lubrificante P-1001
Teflon lubricating slide for P-1001



VA151

2523124

Gancio guidanastro P-1001
Ribbon guide hook P-1001

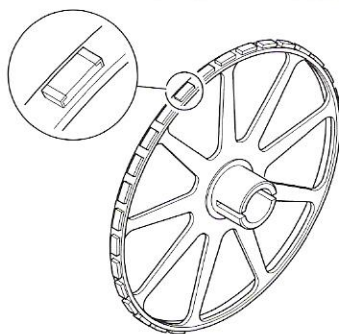

VA152

2398556.1

Dentarella P 401S
Toothed wheel Z33 P401S

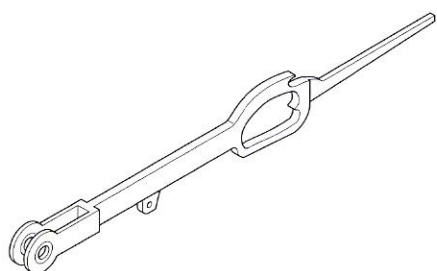

VA153

2548072.1

Asta per presentatrice 401
Selector rod for 401



VA154

2523126

Gancio guidanastro P-1001
Ribbon guide hook P-1001

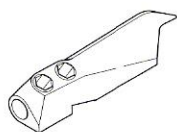

VA155

2523014.2

Testina per pinza portante 401
Head for LH gripper 401



VA156

2142020

Perno di fulcro per pinza P-1001
Fulcrum pin for RH gripper P-1001



Consultoria Textil Import
Export Vendas Manutenção

RICAMBI PER TELAI VAMATEX (Intercambiabili con l'originale)
VAMATEX LOOMS SPARE PARTS (Interchangeable with originals)

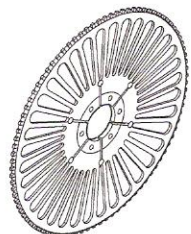

VA157

2548096.1

Dentarella P-1001
Toothed wheel Z.136

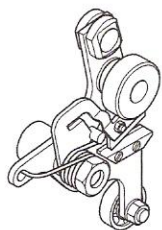

VA158

9300014.2

Taglierina laterale 401
Lateral cutter 401



VA159

2563126

Lamina tenuta trama pinza SX 401
Lamel for LH gripper 401

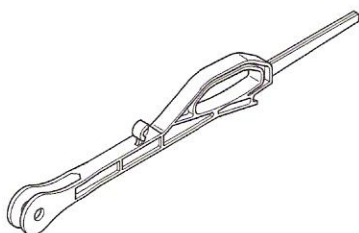

VA160

2548182

Asta per presentatrice P-1001
Selector rod for P-1001

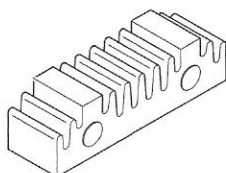

VA161

2500134

Pattino guidanastro
Ribbon-guide sector

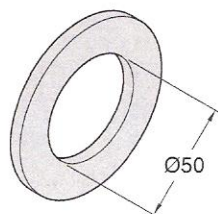

VA162

2149002

Disco frizione avvolgipezza
Lining for clutch



Consultoria Textil Import
Export Vendas Manutenção

RICAMBI PER TELAI VAMATEX (Intercambiabili con l'originale)
VAMATEX LOOMS SPARE PARTS (Interchangeable with originals)

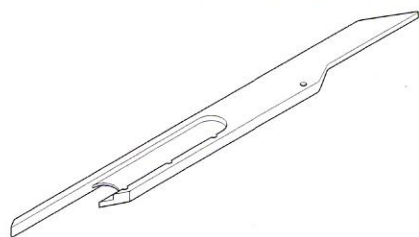

VA163

2508102

Punta Nastro traente sp. 6,5
RH tape point P1001

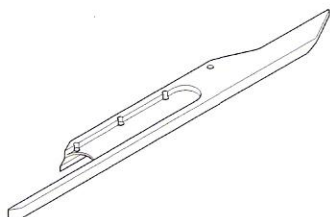

VA164

2508098.1

Punta nastro portante sp.6.5
LH tape point P1001



VA165

2110186

Gancio guidanastro per 201
Tape guiding hook for 201

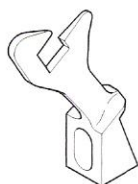

VA166

2523144

Gancio guidanastro Leonardo
Tape guiding hook for Leonardo

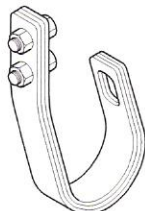

VA167

2563030

Molla per lama mobile
Spring for pos. cutter mobile blade

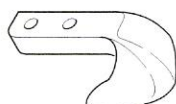

VA168

2549008

Gancio livella trama
Weft levelling hook

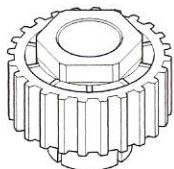
**RICAMBI PER TELAI VAMATEX (Intercambiabili con l'originale)
VAMATEX LOOMS SPARE PARTS (Interchangeable with originals)****VA169**

2558146

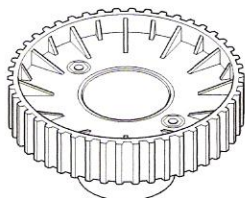
**Puleggia Z=23
Pulley Z=23****VA170**

2558148

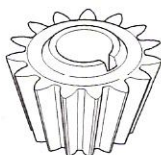
**Puleggia Z=46
Pulley Z=46****VA171**

2398002

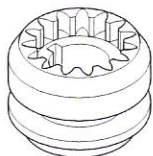
**Pignone conico Z=15 per sblocco
Pinion Z=15 for regulation****VA172**

2398004

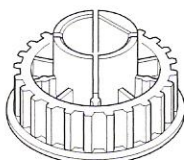
**Innesto per sblocco
Clutch for regulation****VA173**

2398030

**Puleggia Z=23 per com. present
Pulley Z=23****VA174**

2398526

**Puleggia Z=23 per present
Pulley Z=23 for col change dev.****VA175**

2558276

**Dentarella Z=136 Leonardo
Toothed wheel Z=136 Leonardo**

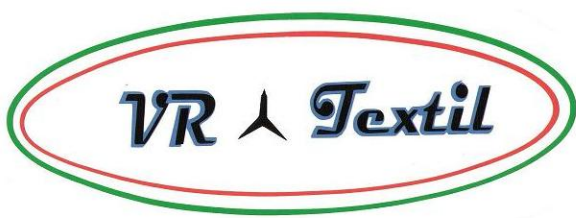

RICAMBI PER TELAI VAMATEX (Intercambiabili con l'originale)
VAMATEX LOOMS SPARE PARTS (Interchangeable with originals)



VA176

2569096

Piastrina di reazione Leonardo
Reaction plate Leonardo

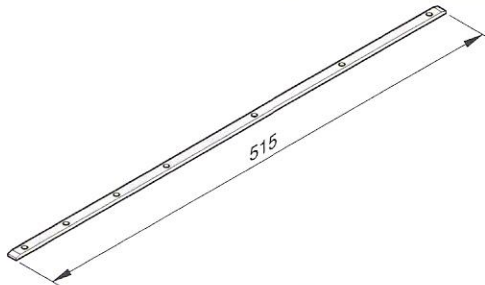

VA177

2508086.2

Piatto di sostegno pinza port. P1001
Support plate for LH gripper P 1001

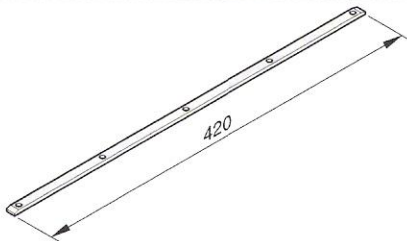

VA178

2508068.1

Reazione per pinza traente P1001
Reaction for RH gripper P 1001



VA179

2508112

Lamina di pressione in carbonio 9000 Plus
Carbon pressare lamella 9000 Plus



VA180

2508114

Lamina di pressione in carbonio 9000 Plus
Carbon pressare lamella 9000 Plus

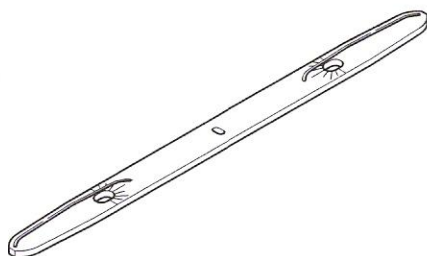

VA181

2509110

Apripinza trazione Leonardo
Leonardo RH gripper opener

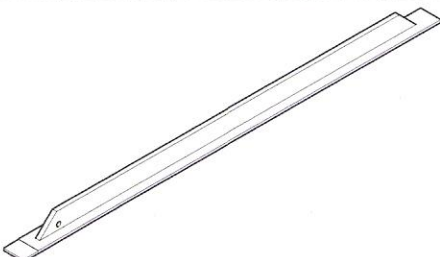

VA182

2589008

Dima per allineam. guide -401-
Template for guide support alignm.

**RICAMBI PER TELAI VAMATEX (Intercambiabili con l'originale)
VAMATEX LOOMS SPARE PARTS (Interchangeable with originals)**

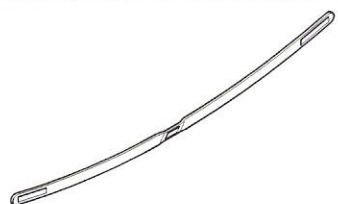

VA183

2563218

Maglia per falsa cimossa
False selvage heald

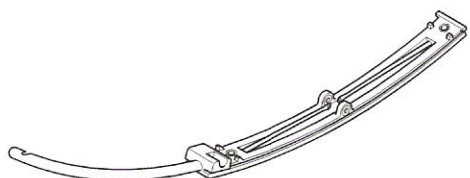

VA184

2558142

Cursore porta aghi-laterale
Lateral carrier needle cursor

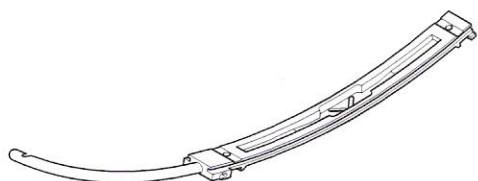

VA185

2558140

Cursore di scambio laterale
Lateral exchange cursor

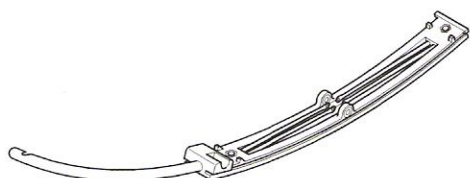

VA186

2558138.1

Cursore di scambio - 2 legature
Exchange cursor 2 bindings

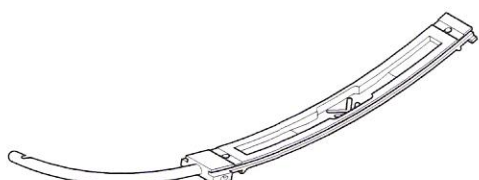

VA187

2558136.1

Cursore di scambio - 2 legature
Exchange cursor 2 bindings



VA188

2503064

Supporto per splitz 2 posizioni
2 position splitz support



VA189

2560063

Supporto per splitz 4 posizioni
4 position splitz support

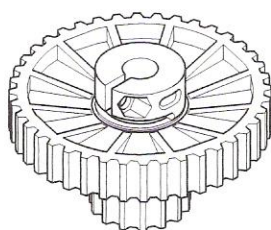
**RICAMBI PER TELAI VAMATEX (Intercambiabili con l'originale)
VAMATEX LOOMS SPARE PARTS (Interchangeable with originals)****VA190**

2398052.1

Puleggia per comando sblocco
C401S - P1001ES
*Pulley for crammng drive
C401 - P1001ES*

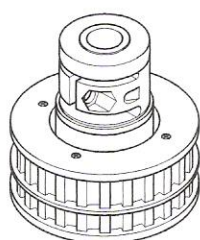
**VA191**

2398066

Puleggia Z=39 C401ES
Pulley Z=39 C401ES

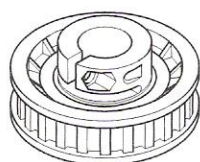
**VA192**

2398068

Puleggia Z=39 comando variatore
C401ES - P1001ES
*Pulley Z=39 for variator
C401ES - P1001ES*

**VA193**

2583116

Lama fissa Leonardo
Fix blade Leonardo

**VA194**

2583114

Lama flessibile Leonardo
Flexible blade Leonardo

**VA195**

2549010

Gancio livellatrama Leonardo
Weft guide hook Leonardo

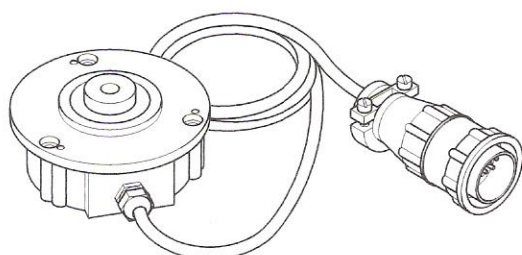
**VA196**

2691602

Encoder per P401S - Typhoon
Encoder for P401S - Typhoon

VA197

2691603

Encoder per P1001 - 1151
Encoder for P1001 - 1151

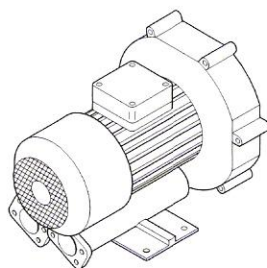
**RICAMBI PER TELAI VAMATEX (Intercambiabili con l'originale)
VAMATEX LOOMS SPARE PARTS (Interchangeable with originals)**

VA198 0892025 Aspiratore 75 cc T1
Suction device 75 cc T1

VA199 0892030 Aspiratore 75 cc T2
Suction device 75 cc T2

VA200 0892031 Aspiratore 75 cc T3
Suction device 75 cc T3



VA201 9120007 Gruppo filtro 401
Filter box 401



VA202 9120053 Gruppo filtro P1001
Filter box P1001

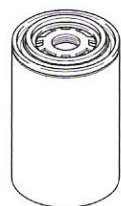

VA203 0483028 Filtro 60 μ
Filter 60 μ

VA204 0483031 Filtro 10 μ
Filter 10 μ

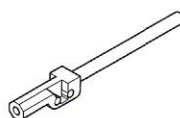

VA205 2548346 Nottolino P1001
Pawel for P1001



VA206 2143044 Bussola in Widia P1001-Leonardo
Bush Widia P1001-Leonardo

**RICAMBI PER TELAI VAMATEX (Intercambiabili con l'originale)
VAMATEX LOOMS SPARE PARTS (Interchangeable with originals)**

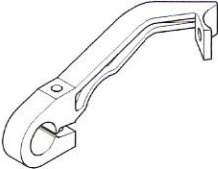
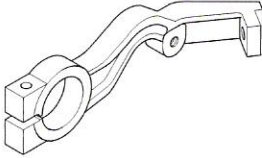
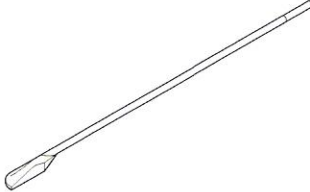
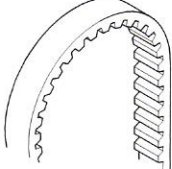
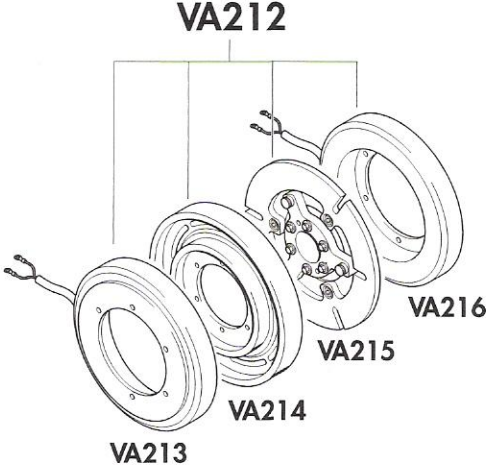
	VA207	2560082	Molla per pinza traente P1001 <i>Spring for RH gripper P1001</i>	
	VA208	2526128.1	Braccio porta lama fissa 401, P1001 <i>Fix blade arm carrier 401, P1001</i>	
	VA209	2526126.2	Braccio porta lama flessibile 401, P1001 <i>Flexible blade arm carrier 401, P1001</i>	
	VA210	2583040	Cursore per trame parallele P1001 <i>Parallel weft cursor P1001</i>	
	VA211	0423021	Cinghia per chitarra 980X H 138-5 HPR T±1,6 mm <i>Toothed belt 980X H 138-5 HPR T±1,6 mm</i>	
	VA212	VA212	2690027.1	Freno frizione completo P1001 <i>Complete clutch brake P1001</i>
		VA213	2690035	Magnete <i>Magnet</i>
		VA214	2690033	Rotore <i>Rotor</i>
		VA215	2690031	Ancora <i>Armature</i>
		VA216	2690029	Magnete <i>Magnet</i>

**RICAMBI PER TELAI VAMATEX (Intercambiabili con l'originale)
VAMATEX LOOMS SPARE PARTS (Interchangeable with originals)**



VA217

2526124.1

Leva per pinza traente con bussola e vite - 401

Lever for RH gripper with screw and bush - 401

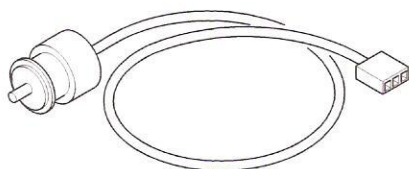

VA218

9820993

Encoder principale - Leonardo

Main encoder - Leonardo

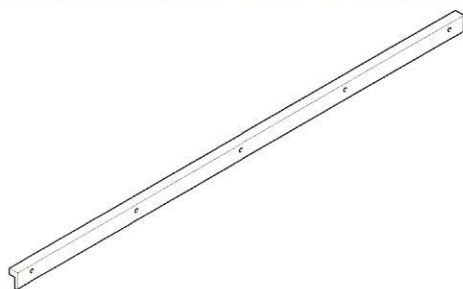

VA219

2509092

Reazione per pinza traente Leonardo

Reaction for RH gripper Leonardo

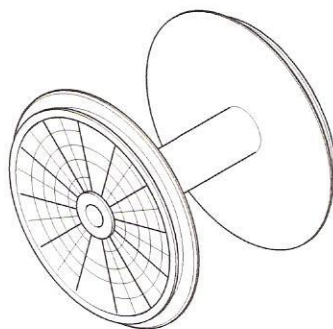

VA220

2248002

Rochellone - 401 - P1001 - Leonardo - SP1151ES

Spool for false selvage - 401 - P1001 - Leonardo - SP1151ES

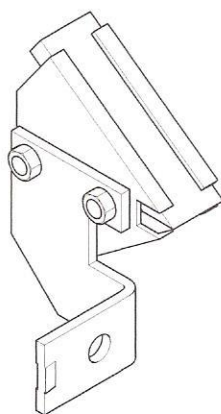

VA221

9120291

Gruppo teflonatore sup - Leonardo
Upper tefloning group - Leonardo

VA222

9120292

Gruppo teflonatore inf - Leonardo
Lower tefloning group - Leonardo

VA223

9120273

Gruppo teflonatore sup - Leonardo
Upper tefloning group - Leonardo

VA224

9120299

Gruppo teflonatore inf - Leonardo
Lower tefloning group - Leonardo



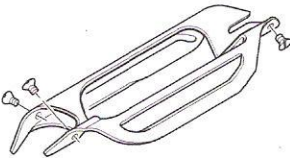
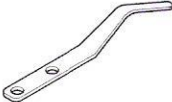
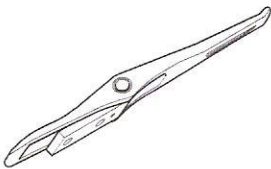
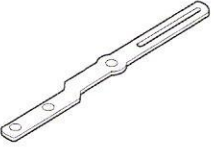
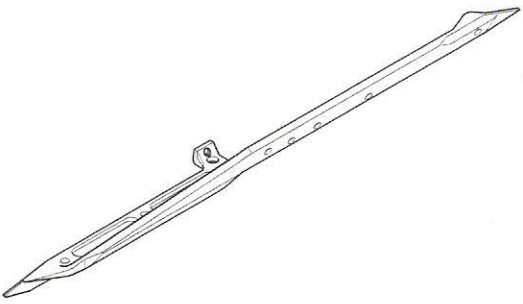
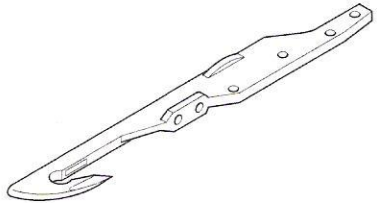

RICAMBI PER TELAI VAMATEX (Intercambiabili con l'originale)
VAMATEX LOOMS SPARE PARTS (Interchangeable with originals)

	VA225	9300085	Taglierina destra P1001 - 9000 Plus - Leonardo <i>RH mechanical lateral cutter</i> P1001 - 9000 Plus - Leonardo
	VA226	9300064	Taglierina sinistra P1001 - 9000 Plus - Leonardo <i>LH mechanical lateral cutter</i> P1001 - 9000 Plus - Leonardo
	VA227	2522108	Lama per taglierina P1001 - 9000 Plus - Leonardo <i>Cutter blade</i> P1001 - 9000 Plus - Leonardo
	VA228	0423013.1	Cinghia dentata per presentatrice C401S - P1001ES - SP1151ES <i>Toothed belt for weft selector</i> C401S - P1001ES - SP1151ES 480 RHP8 - 15 ± 0,8 m
	VA229	0423018	Cinghia dentata per comando splitz C401S - 9000 Plus ES - P1001ES - SP1151ES <i>Toothed belt for leno device - C401S -</i> 9000 Plus ES - P1001ES - SP1151ES 1040 RHP 8-20 ± 0,8 m
	VA230	9300084	Taglierina centrale 9000 Plus ES - P1001ES - K88 - Leonardo <i>Central cutter 9000 Plus ES -</i> P1001ES - K88 - Leonardo
	VA231	9340199	Kit canotto tagliente flessibile P1001 - SP1151 - 9000 Plus <i>Kit Hollow shaft for mob. positive</i> cut P1001 - SP1151 - 9000 Plus
	VA232	9340200	Kit canotto tagliente fisso P1001 - SP1151 - 9000 Plus <i>Kit Hollow shaft for fix positive cut</i> P1001 - SP1151 - 9000 Plus
	VA233	2548670	Deviafilo per barra recupero fili 9000 Plus ES - Leonardo - P1001ES <i>Thread guide</i> 9000 Plus ES - Leonardo - P1001ES

**RICAMBI PER TELAI VAMATEX (Intercambiabili con l'originale)
VAMATEX LOOMS SPARE PARTS (Interchangeable with originals)**

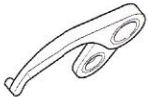
	VA234	9120370	Kit Falcon Leonardo <i>Falcon Kit Leonardo</i>
	VA235	9120370	Kit Falcon Leonardo - R.T.S. <i>Falcon Kit Leonardo - R.T.S.</i>
	VA236	2563442	Lamina di pressione Leonardo <i>Pressure lamina Leonardo</i>
	VA237	2563476	Lamina di pressione leggera (blu) <i>Pressure lamina light (blue)</i>
	VA238	9120338	Kit leva completa Leonardo <i>Complete lever kit Leonardo</i>
	VA239	2563446	Lamina di tenuta con asola Leonardo <i>Plate with loop - Leonardo</i>
	VA240	9120343	Kit corpo pinza portante Leonardo <i>LH gripper kit body Leonardo</i>
	VA241	2583098	Gancio piano per pinza traente Leonardo <i>Plain hook for RH gripper Leonardo</i>
	VA242	2583099	Gancio scanalato per pinza traente Leonardo <i>Grooved hook for RH gripper Leonardo</i>

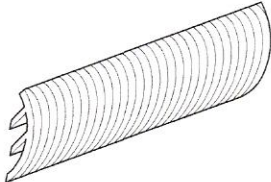
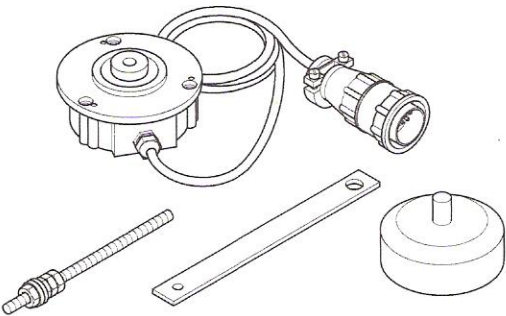
**RICAMBI PER TELAI VAMATEX (Intercambiabili con l'originale)
VAMATEX LOOMS SPARE PARTS (Interchangeable with originals)**

	VA243	2523156	Leva per pinza traente Leonardo <i>RH gripper lever Leonardo</i>
	VA244	2583102	Balestra piana (blu) <i>Flat leaf spring F/Nor weft</i>
	VA245	2583106	Balestra piana per trame parallele (rossa) <i>Flat leaf spring F/parallel weft</i>
	VA246	2583104	Balestra scanalata <i>Grooved leaf spring for RH gripper</i>
	VA247	2583100	Cursore per pinza traente <i>Slider for RH gripper</i>
	VA248	2548450.1	Deviatessuto sinistro C401-P1001ES-9000+ <i>LH cloth deviator C401-P1001ES-9000+</i>
	VA249	2548452.1	Deviatessuto destro C401-P1001ES-9000+ <i>RH cloth deviator C401-P1001ES-9000+</i>
	VA250	9380041	Kit sostituzione encoder 401-S-SP251 <i>Encoder replacement kit 401-S-SP251</i>
	VA251	2583146	Lama flessibile Leonardo <i>Mobile blade Leonardo</i>
	VA252	2583148	Lama rigida Leonardo <i>Fix blade Leonardo</i>

**Ricambi per telai VAMATEX (Intercambiabili con gli originali)
VAMATEX looms spare parts (Interchangeable with originals)**

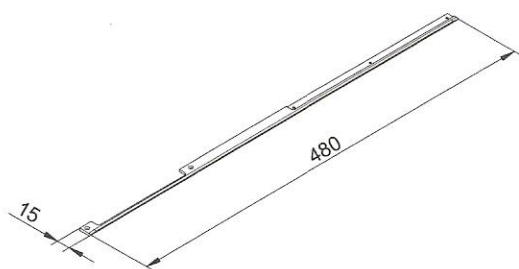

VA253

2509120

Reazione per pinza portante
Leonardo - K88

*Reaction for LH gripper
Leonardo - K88*

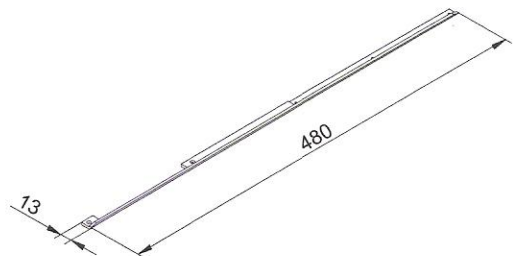

VA254

2509122

Reazione per pinza portante
P1001ES - SP1151ES

*Reaction for LH gripper
P1001ES - SP1151ES*



VA255

2658002

Cassetta filtro aspiratore
C201 - C301 - C401 - P1001 - SP1151

*Suction filter box
C201 - C301 - C401 - P1001 - SP1151*



VA256

2558002

Secchiello per filtro aspiratore
C201 - SP151 - C301 - C401 - P1001ES

*Container for suction filter box
C201 - SP151 - C301 - C401 - P1001ES*



VA257

2548062

Filtro per aspiratore
C401S - 9000+ - Leonardo - P1001 - SP1151

*Suction filter
C401S - 9000+ - Leonardo - P1001 - SP1151*

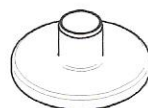

VA258

2148048

Coperchio per aspiratore
C401S

*Suction cover
C401S*



VA259

2548542

Coperchio per aspiratore
P1001

*Suction cover
P1001*

Ricambi per telai VAMATEX (Intercambiabili con gli originali)
VAMATEX looms spare parts (Interchangeable with originals)

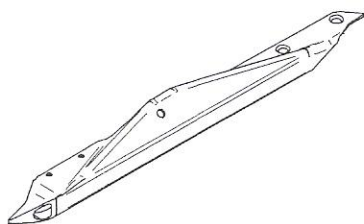

VA260

2583064

Corpo pinza traente
Leonardo - K2000

*RH gripper body
Leonardo - K2000*

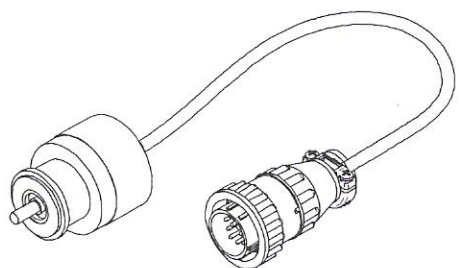

VA261

9850372

Encoder 360° cablato
Leonardo - Alpha - Mythos - Silver

*Encoder pulse 360° cabled
Leonardo - Alpha - Mythos - Silver*

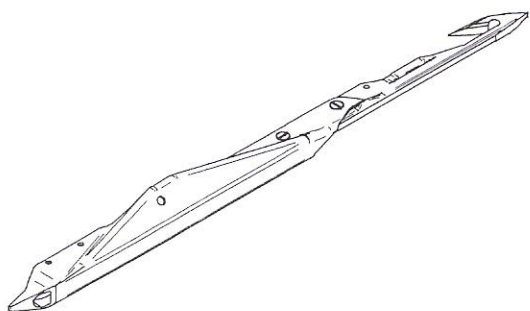

VA262

9120329

Kit copro pinza traente + gancio
scanalato
Leonardo - K2000

*RH gripper body kit + grooved hook
Leonardo - K2000*

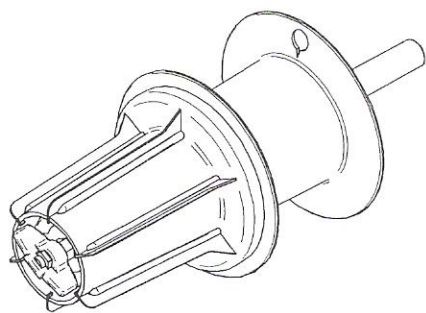

VA263

2691454.1

Tiracimossa con recupero fili

Selvedge take-up with ends recover

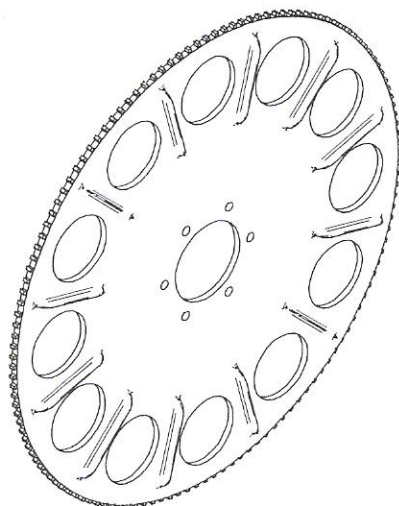

VA264

2558448.1

Dentarella con alette
Leonardo - Silver

*Drive wheel with wings
Leonardo - Silver*

**LAME PER TAGLIO SOMET (Intercambiabili con l'originale)
CUTTER BLADES SOMET (Interchangeable with originals)**



BDY109C THEMA-EXCEL

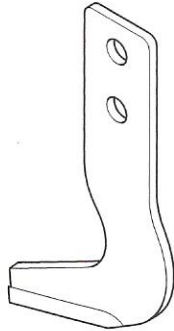

ADY106C MASTER-THEMA-EXCEL

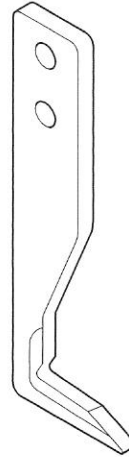

ADY107C MASTER

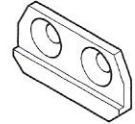

EWM023A UV-ST-MASTER-THEMA

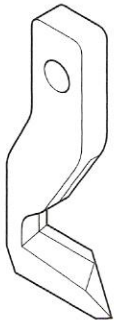

A1L596A ST-UV

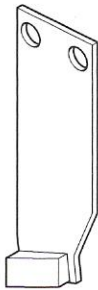

A1L598B ST-UV

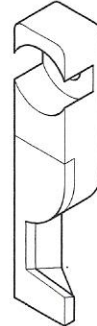

R62076Y AC2S

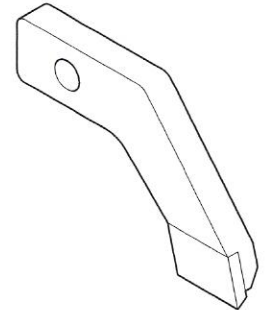

R62077Y AC2S

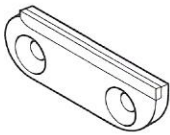

CMN410A AC2S-FIERA-DX

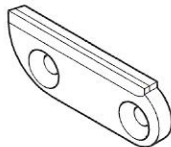

CMN411A AC2S-FIERA-SX

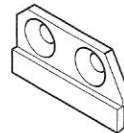

R64070X AC2S/1

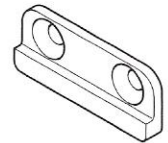

HLT062A EXCEL

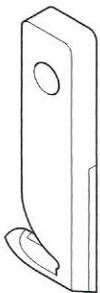

A1L446A UV3

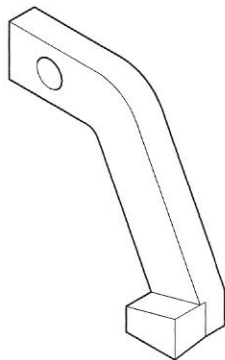

A1L425A UV3

TIRACIMOSSA CON FRIZIONE
WASTE SELVEDGE CONVEYOR WITH CLUTCH

SOMET-THEMA RÜTI *

* Nella ordinazione precisare il
modello del telaio e il \varnothing dell'albero

* On order, please specify
loom model and shaft diameter

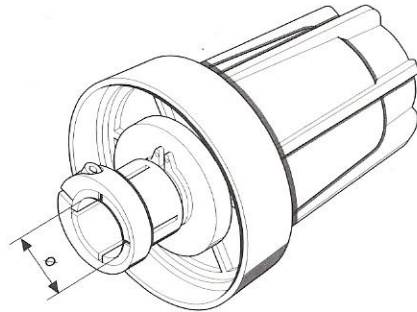

TT0100

SOMET - MASTER SM92

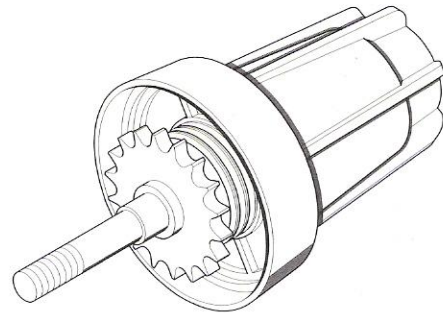

TM0092

SOMET - MASTER SM93

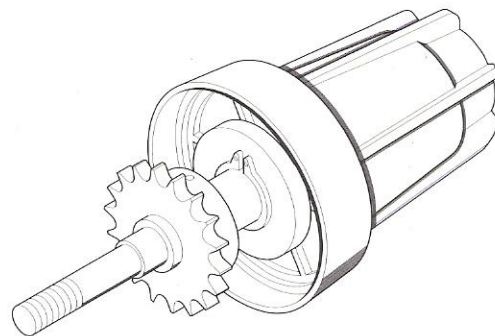

TM0093

VAMATEX 201 - 401 - P 1001

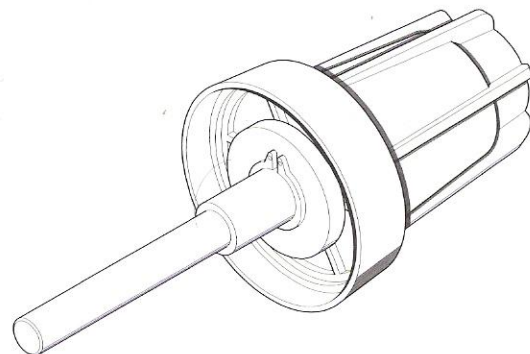

TV0001



**NASTRI PER TELAIO VAMATEX
RAPIER TAPE FOR VAMATEX LOOMS**

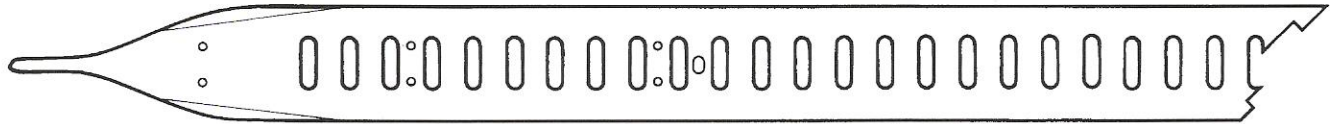

Nastro VAMATEX - Tipo C201 Destro/Sinistro Art. N200
VAMATEX rapier tape - Type C201 Right/Left Art. N200

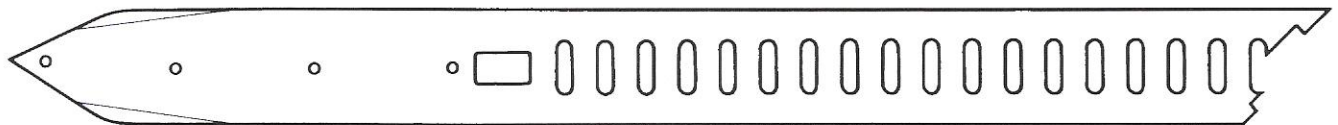

Nastro VAMATEX - Tipo C201/401 Destro/Sinistro Art. N201
VAMATEX rapier tape - Type C201/401 Right/Left Art. N201

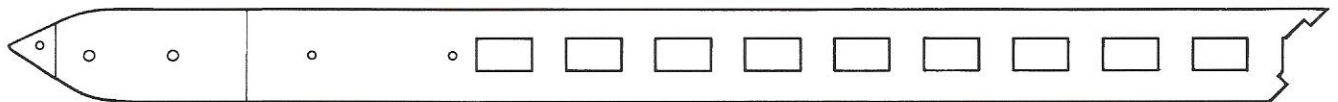

Nastro VAMATEX - Tipo C401 e P401 Art. N202
VAMATEX rapier tape - Type C401 and P401 Art. N202



Nastro VAMATEX - Tipo P1001 Destro Art. N203
VAMATEX rapier tape - Type P1001 Right Art. N203



Nastro VAMATEX - Tipo P1001 Sinistro Art. N204
VAMATEX rapier tape - Type P1001 Left Art. N204

**NASTRI PER TELAIO VAMATEX
RAPIER TAPE FOR VAMATEX LOOMS**

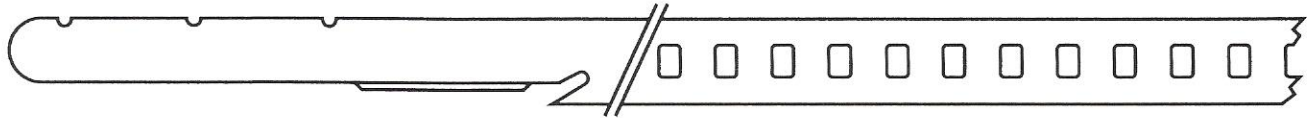

Nastro VAMATEX - Tipo P1001 Destro con punta intercambiabile Art. N205
VAMATEX rapier tape - Type P1001 Right with changeable point Art. N205

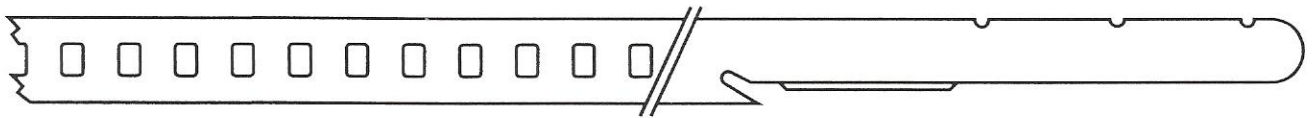

Nastro VAMATEX - Tipo P1001 Sinistro con punta intercambiabile Art. N206
VAMATEX rapier tape - Type P1001 Left with changeable point Art. N206



Nastro VAMATEX - Tipo 9000 Plus Destro/Sinistro con punta in carbonio, spessore 3 mm Art. N207
VAMATEX rapier tape - Type 9000 Plus Right/Left with carbon point, thickness 3 mm Art. N207

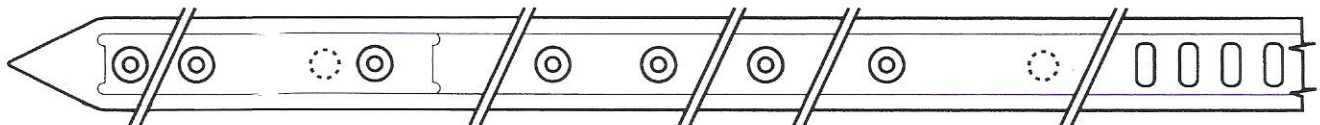

Nastro VAMATEX - Tipo 9000 Plus Destro/Sinistro con punta in carbonio, spessore 4 mm Art. N208
VAMATEX rapier tape - Type 9000 Plus Right/Left with carbon point, thickness 4 mm Art. N208

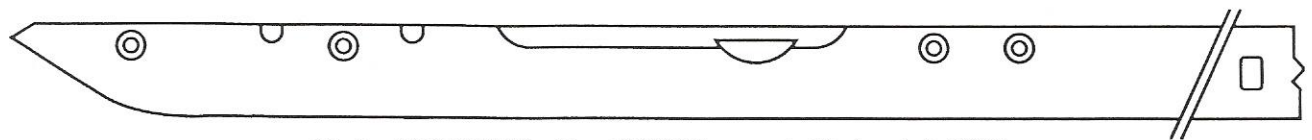

Nastro VAMATEX - Tipo K2000 Leonardo Destro Art. N209
VAMATEX rapier tape - Type K2000 Leonardo Right Art. N209

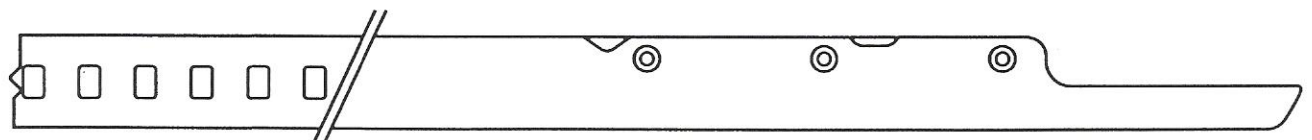

Nastro VAMATEX - Tipo K2000 Leonardo Sinistro Art. N210
VAMATEX rapier tape - Type K2000 Leonardo Left Art. N210



Consultoria Textil Import
Export Vendas Manutenção

VAMATEX 401 ALLUMINIUM GRIPPERS - made in Italy
(INTERCHANGEABLE WITH ORIGINALS)



LH
GX2040

RH
GX1000



**PINZA TRAENTE (RH) PER TELAIO VAMATEX MOD. 201-401
(INTERCAMBIABILI CON L'ORIGINALE)**

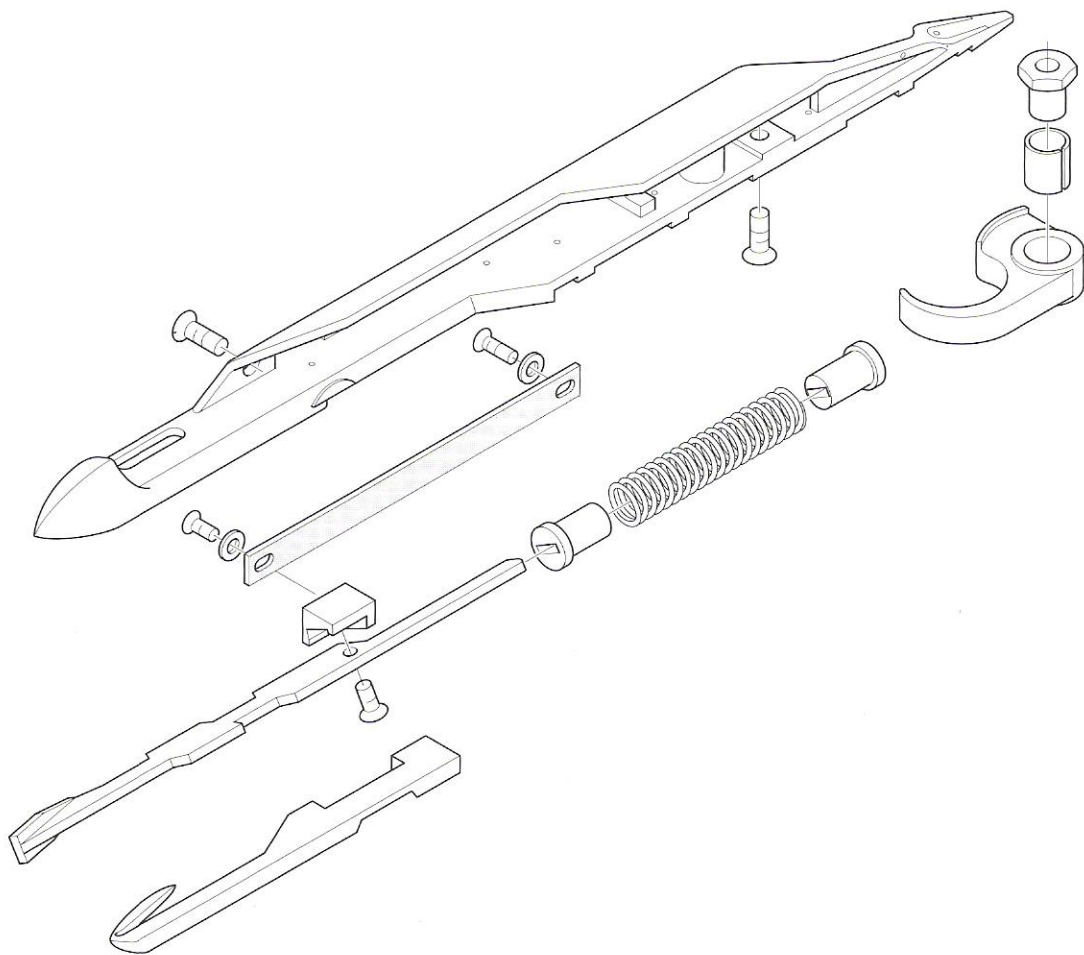

VA 1000

9120043



**PINZA TRAENTE (RH) CON PATTINO PER TELAIO VAMATEX MOD. C401-P401
(INTERCAMBIABILI CON L'ORIGINALE)**

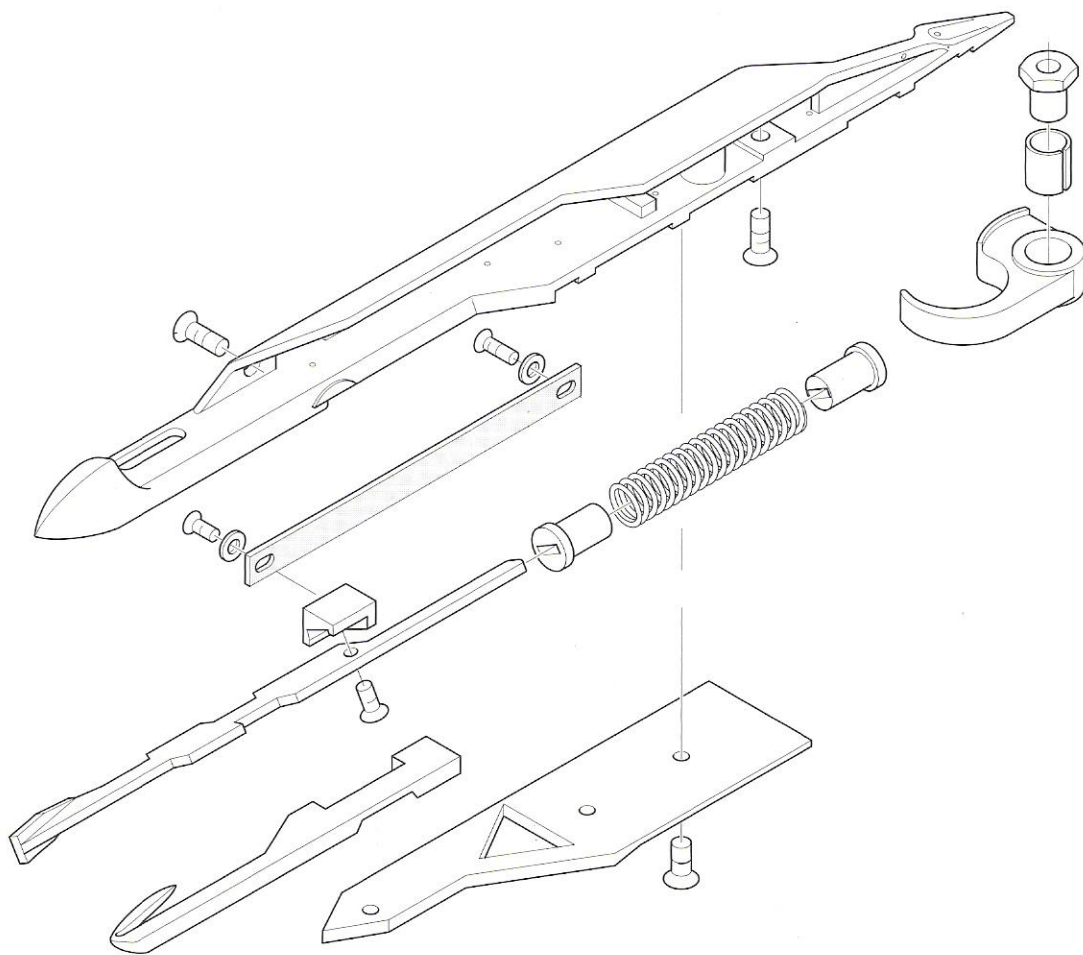

VA 1100

9120281



**Consultoria Textil Import
Export Vendas Manutenção**

**PINZA PORTANTE (LH) PER TELAIO VAMATEX MOD. 201-401
(INTERCAMBIABILI CON L'ORIGINALE)**

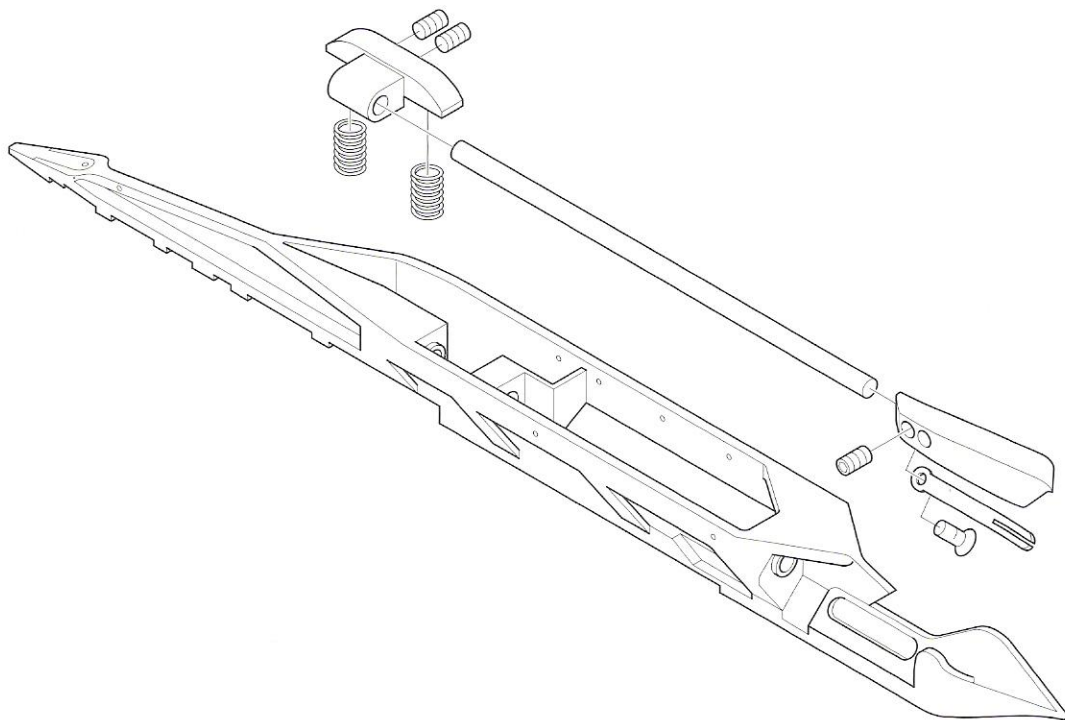

VA 2000

9120044



Consultoria Textil Import
Export Vendas Manutenção

**PINZA PORTANTE (LH) CON PATTINO PER TELAIO VAMATEX MOD. C401-P401
(INTERCAMBIABILI CON L'ORIGINALE)**

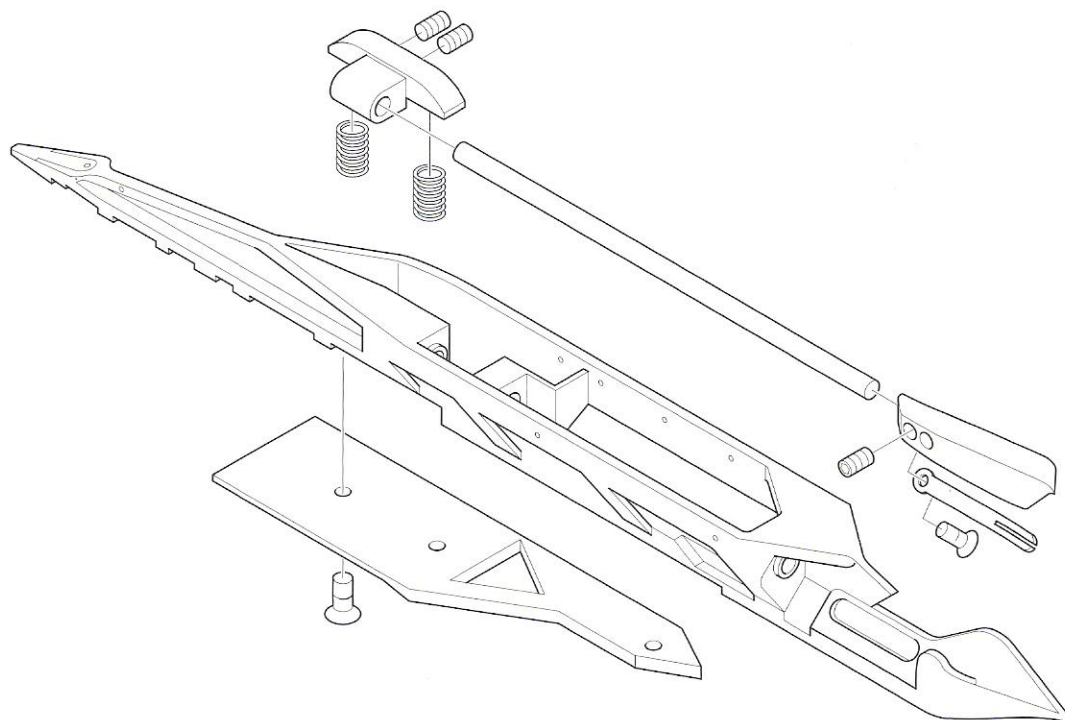

VA 2100

9120280



Consultoria Textil Import
Export Vendas Manutenção

TIRACIMOSSA UNIVERSALE UNIVERSAL WASTE SELVEDGE CONVEYOR



- **Semplicità di installazione**
Easy mounting
- **Nessuna manutenzione**
Maintenance - free
- **Valido per qualsiasi tessuto**
For all kinds of fabric
- **Applicabile a tutti i telai**
*Can be mounted on
all kinds of loom*

